

**Applicable Model**

MD06

**Drawing Title**

Intercom Panel

**Drawing Unit**

mm

**Drawing Scale**

Not to scale

**DRAFT  
SUBJECT TO  
CHANGE**

**Last Revised**

Oct 30,2023

**Drawing Version**

V1.0

**Page**

1 of 8

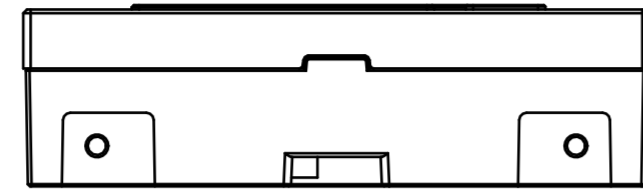

⑤ TOP VIEW

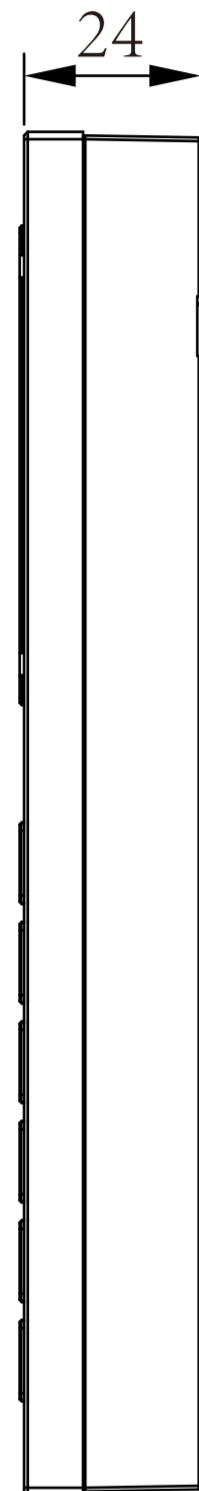

② RIGHT VIEW

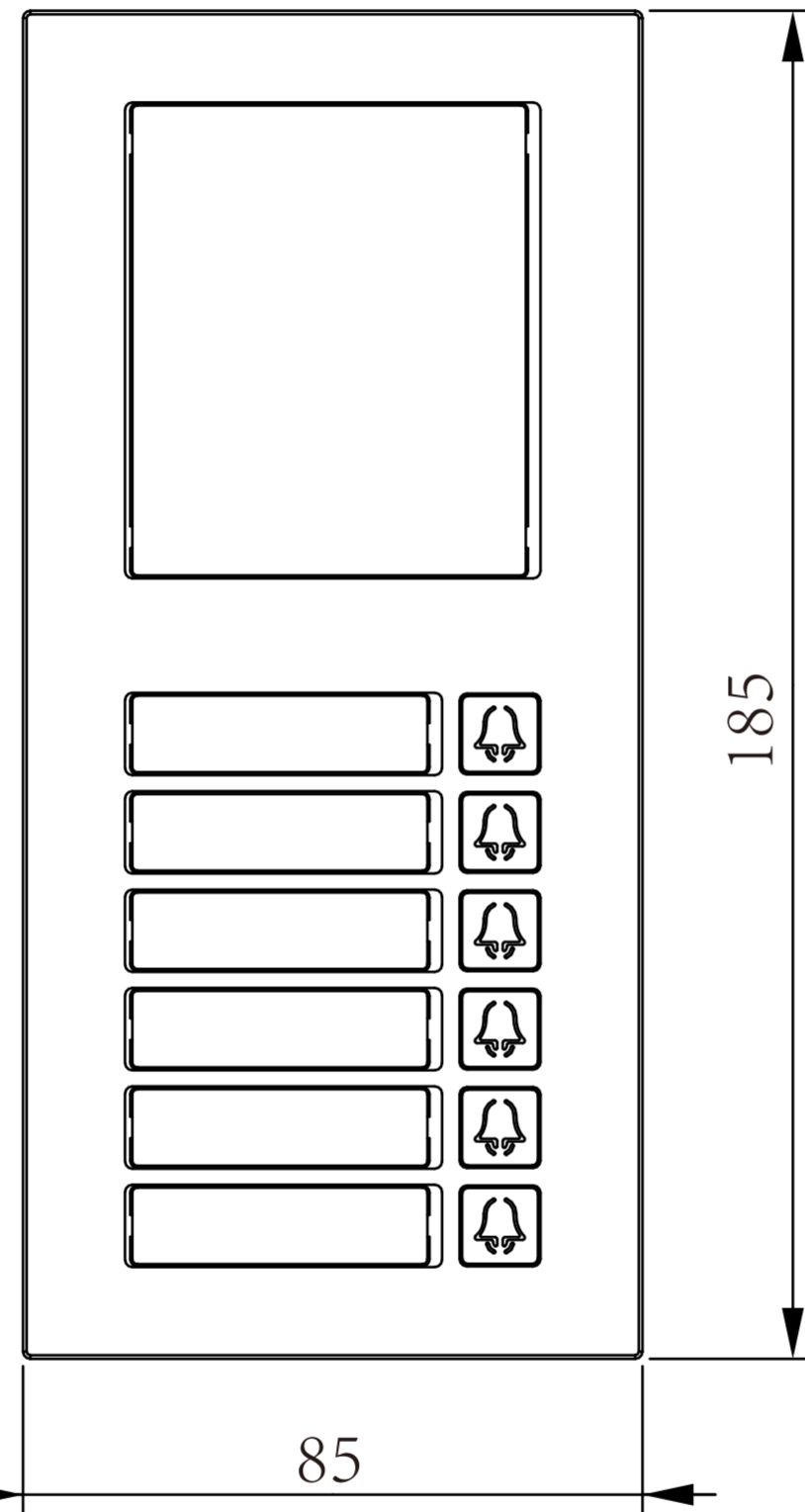

① FRONT VIEW



③ LEFT VIEW

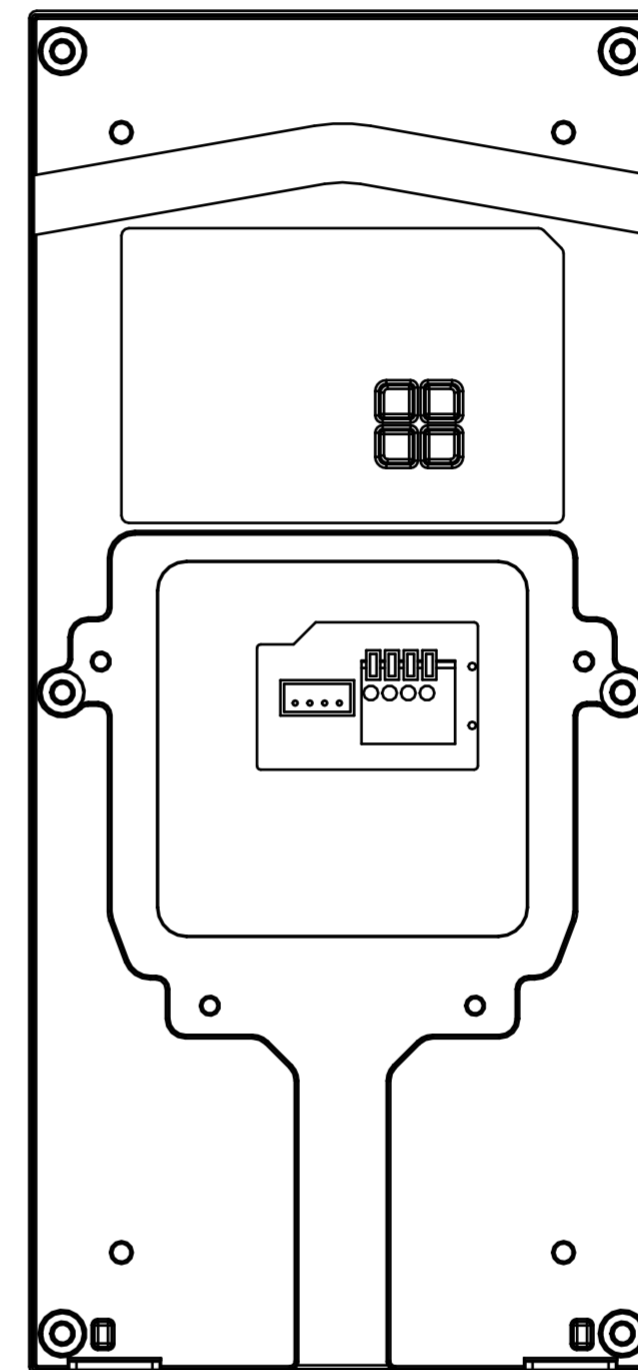

④ BACK VIEW

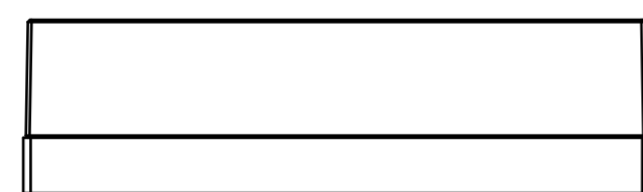

⑥ BOTTOM VIEW

**Applicable Model**

MD12

**Drawing Title**

Intercom Panel

**Drawing Unit**

mm

**Drawing Scale**

Not to scale

**DRAFT  
SUBJECT TO  
CHANGE**

**Last Revised**

Oct 30,2023

**Drawing Version**

V1.0

**Page**

2 of 8

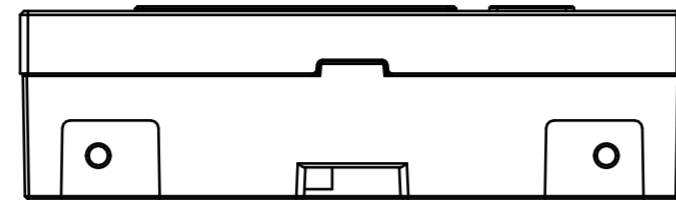

⑤ TOP VIEW

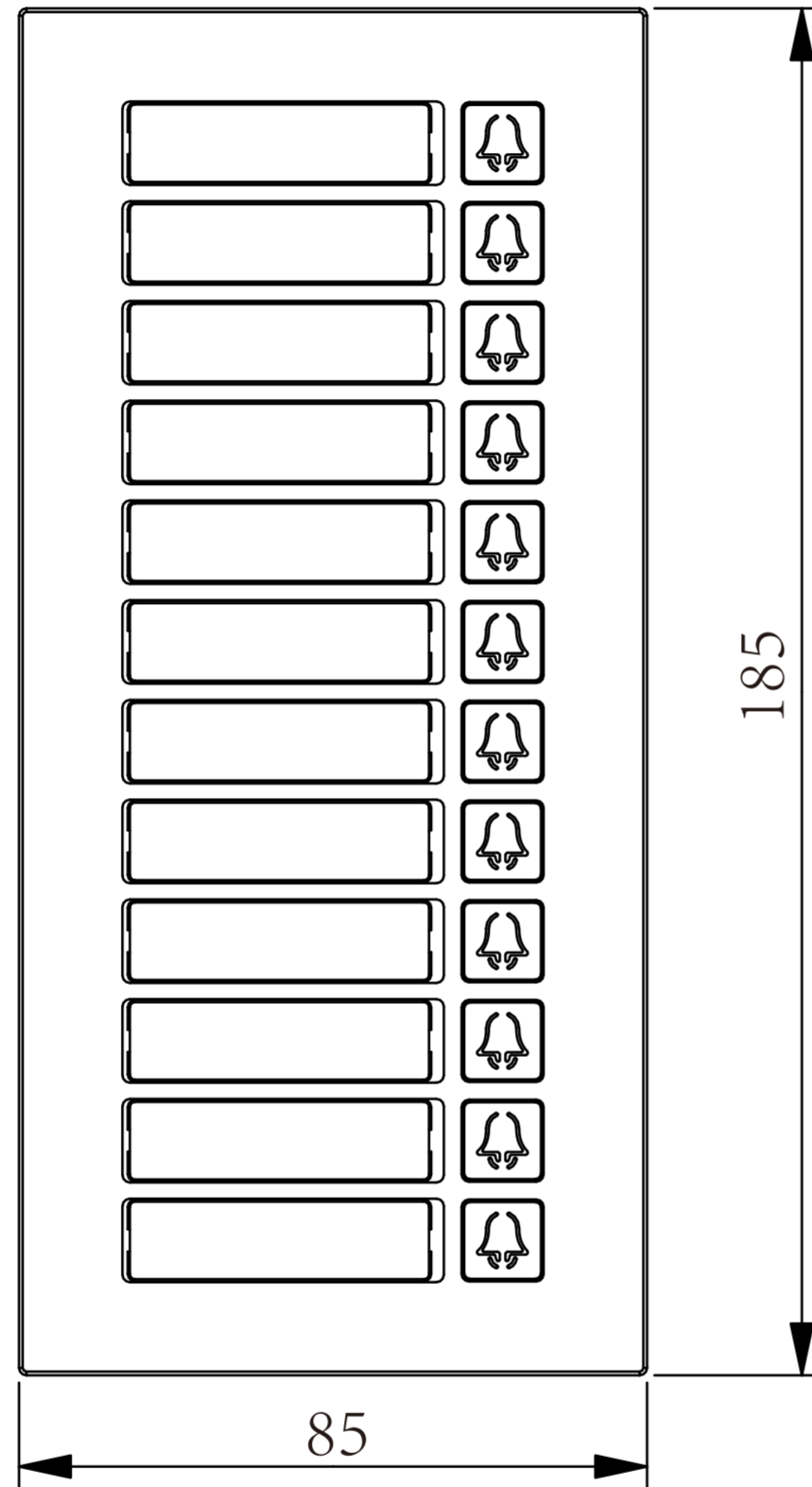

① FRONT VIEW

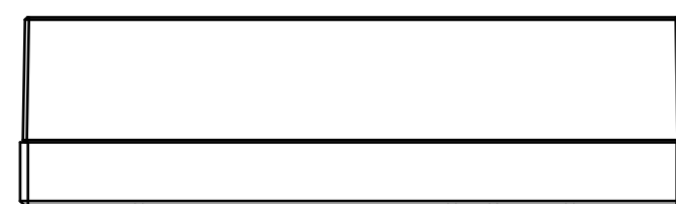

⑥ BOTTOM VIEW

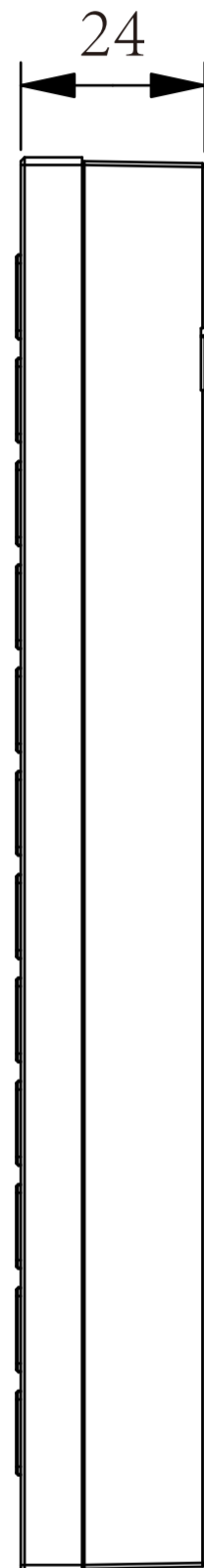

② RIGHT VIEW

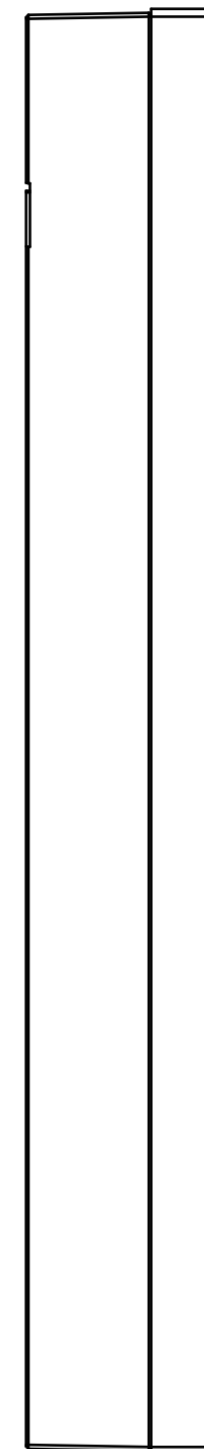

③ LEFT VIEW

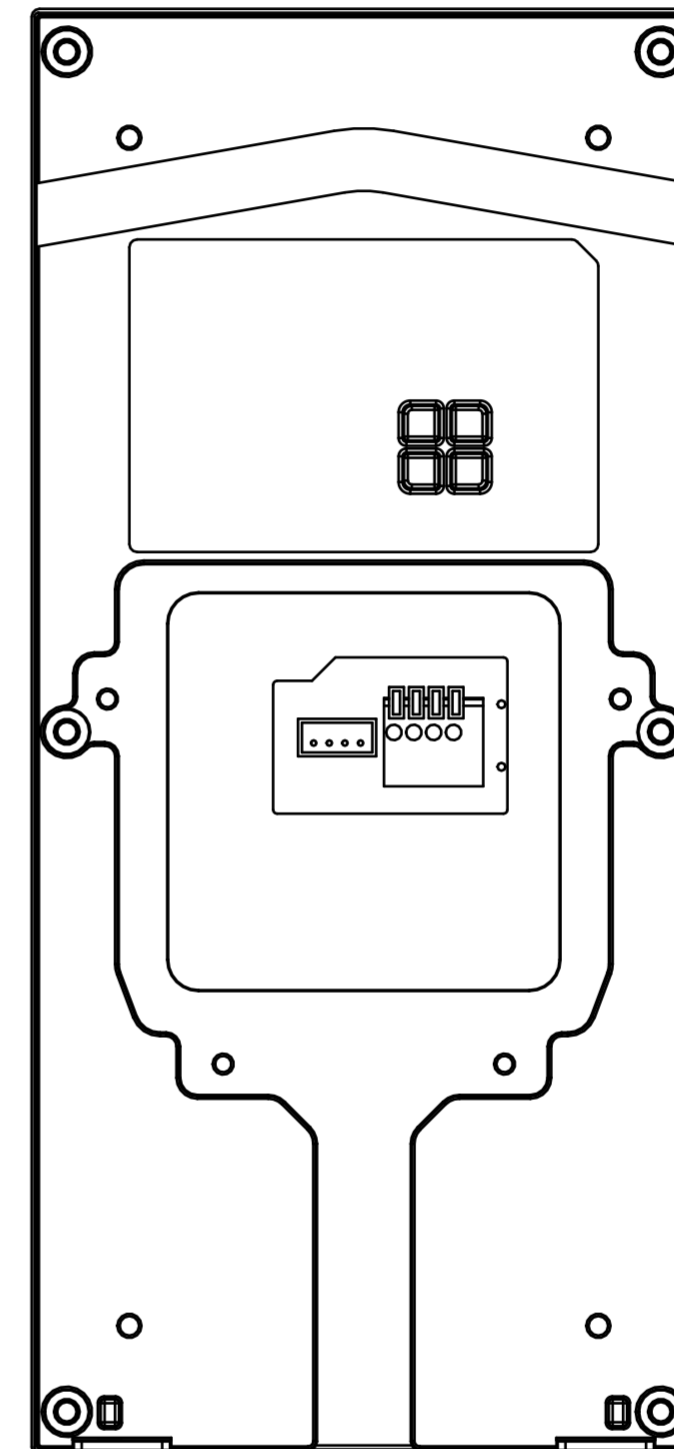

④ BACK VIEW

**Applicable Model**

MD06-12

**Drawing Title**

Duplex Decorative Panel

**Drawing Unit**

mm

**Drawing Scale**

Not to scale

**DRAFT  
SUBJECT TO  
CHANGE**

**Last Revised**

Oct 30,2023

**Drawing Version**

V1.0

**Page**

3 of 8

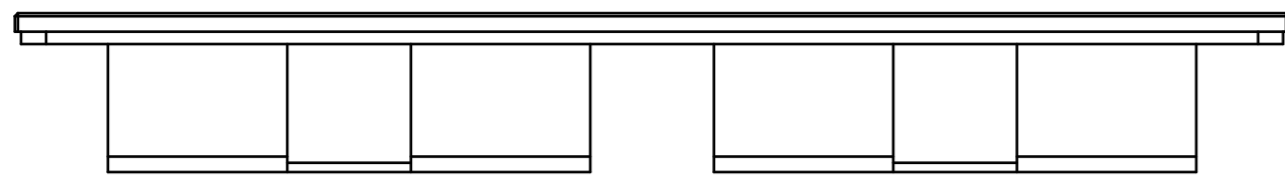

⑤ TOP VIEW

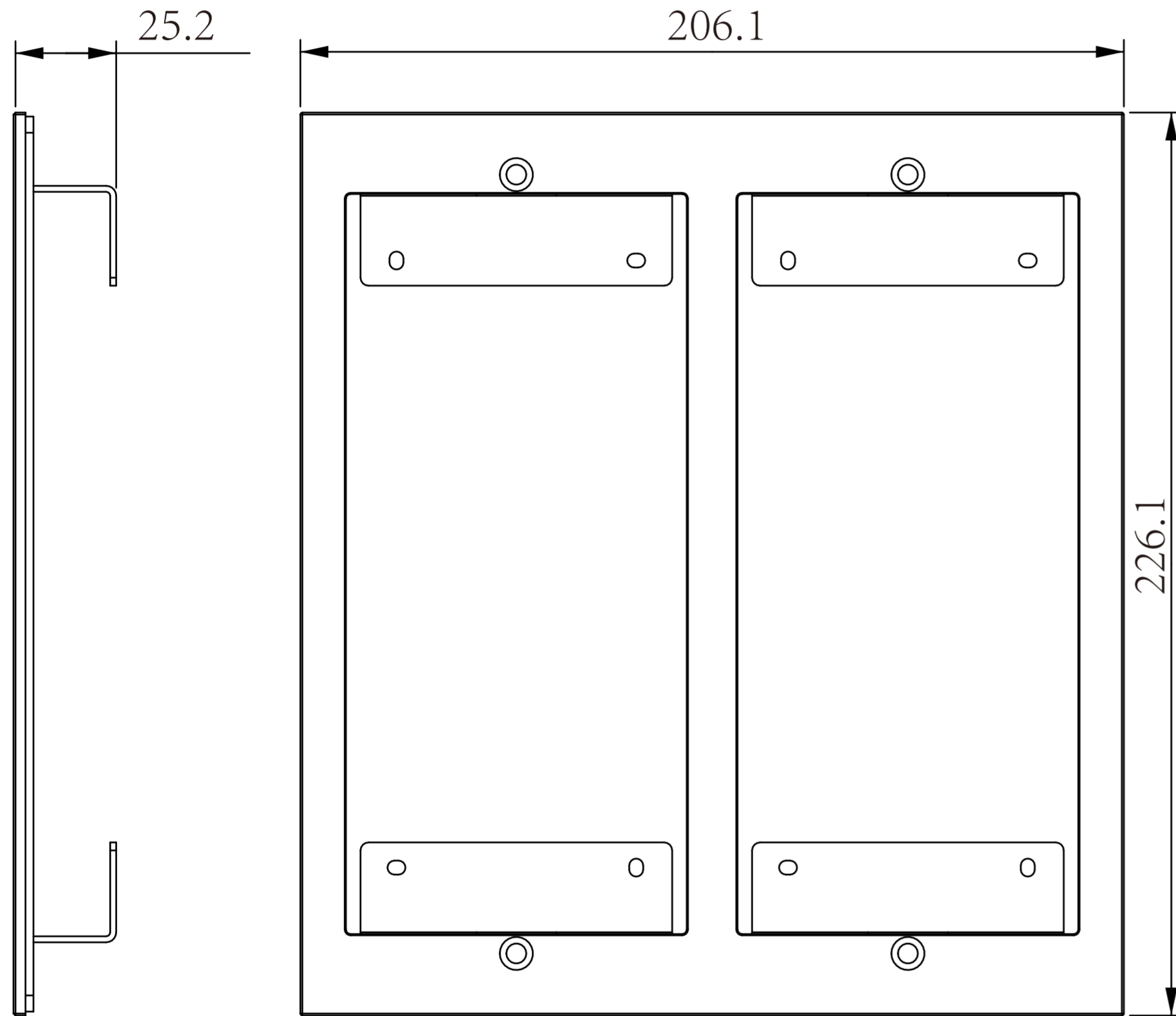

① FRONT VIEW

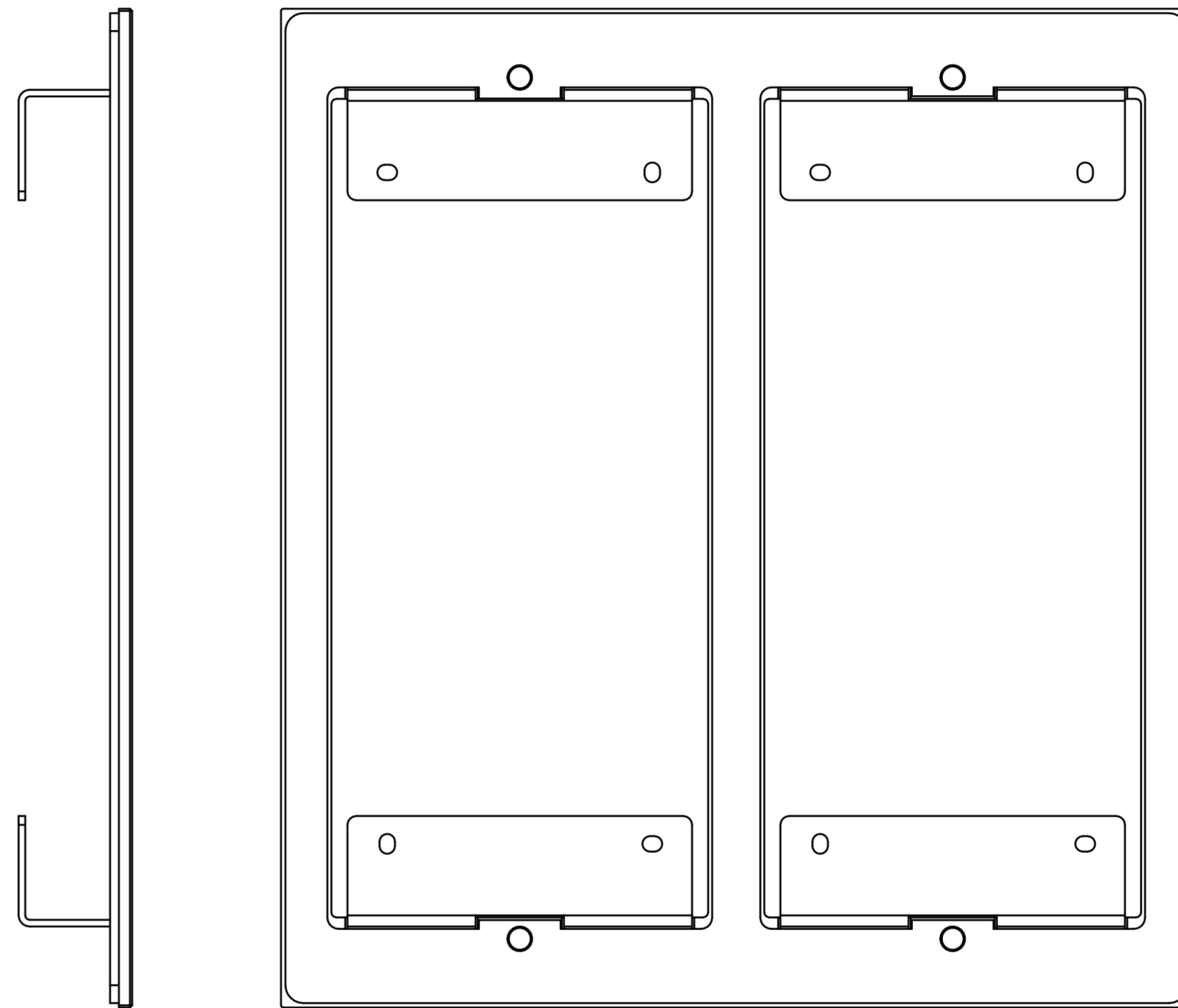

④ BACK VIEW

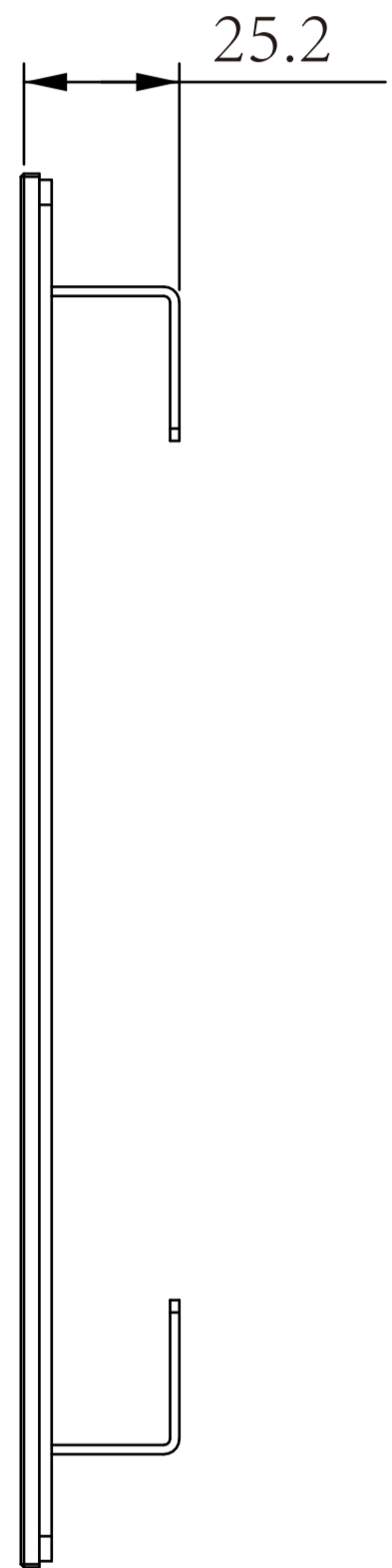

② RIGHT VIEW

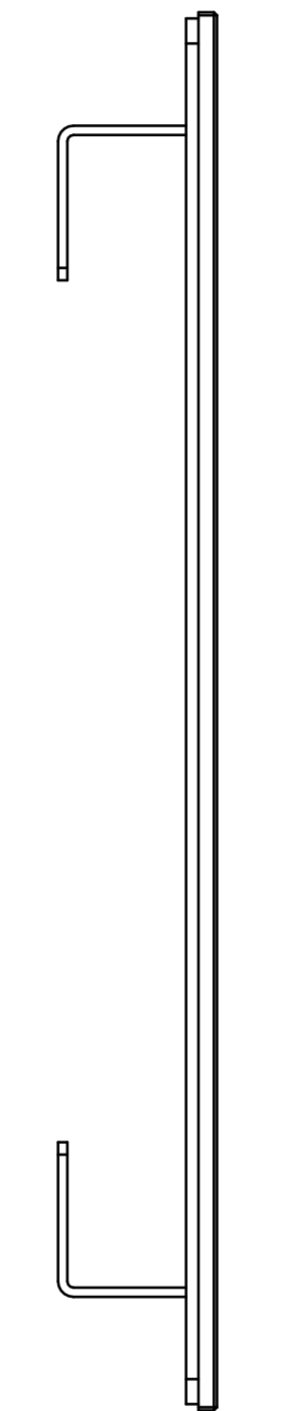

③ LEFT VIEW

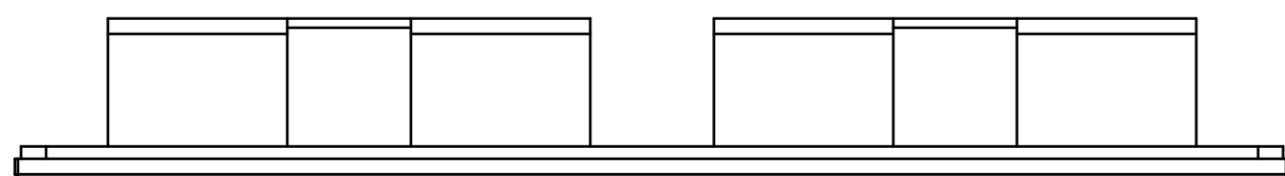

⑥ BOTTOM VIEW

**Applicable Model**

MD06-12

**Drawing Title**

Duplex Flush  
Mounting Box

**Drawing Unit**

mm

**Drawing Scale**

Not to scale

**DRAFT  
SUBJECT TO  
CHANGE**

**Last Revised**

Oct 30,2023

**Drawing Version**

V1.0

**Page**

4 of 8

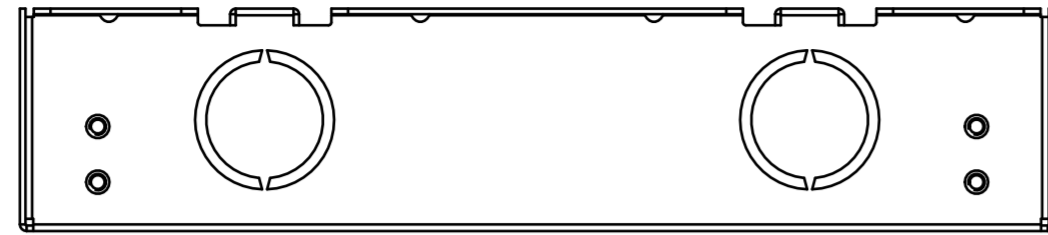

⑥ **BOTTOM VIEW**

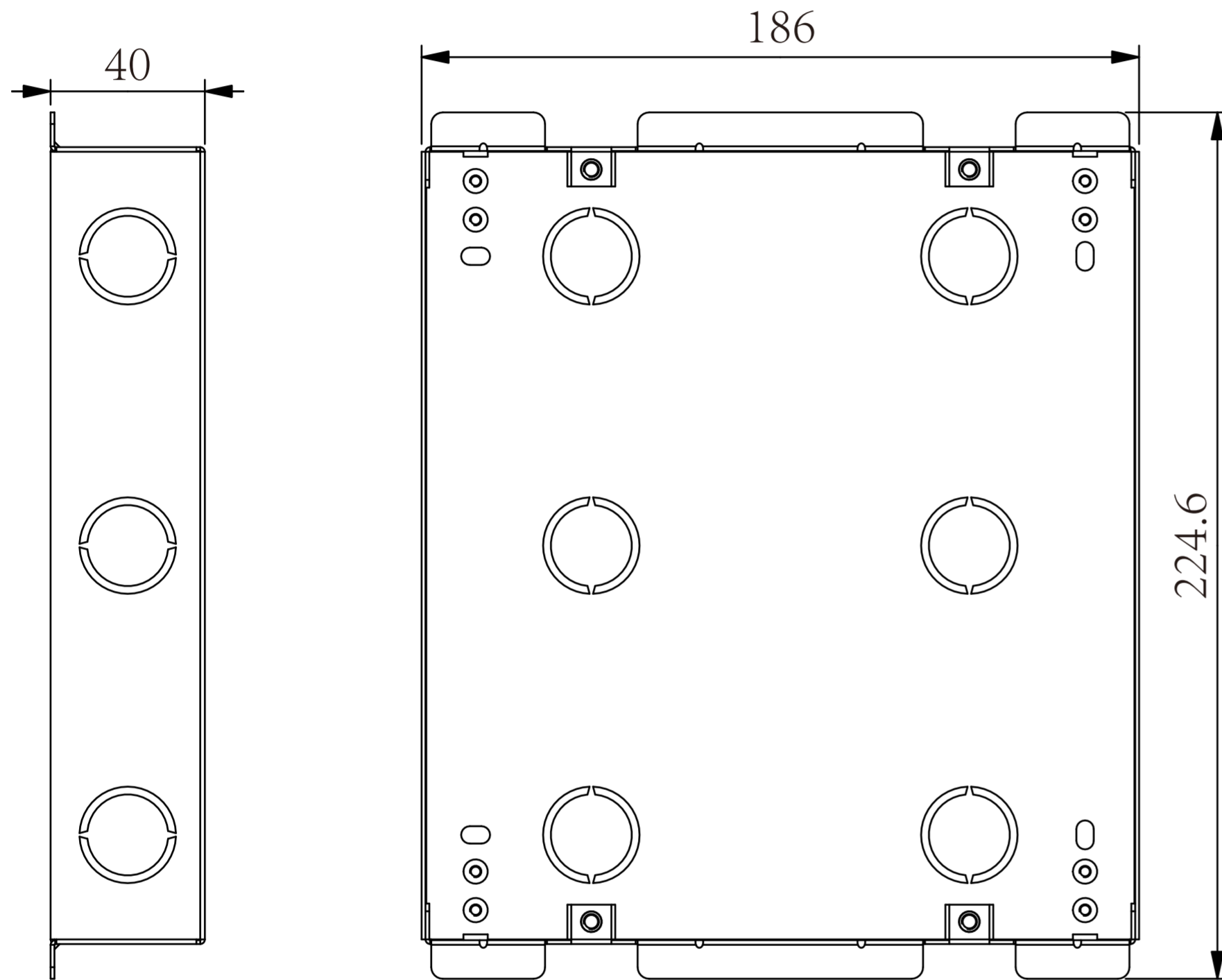

① **FRONT VIEW**

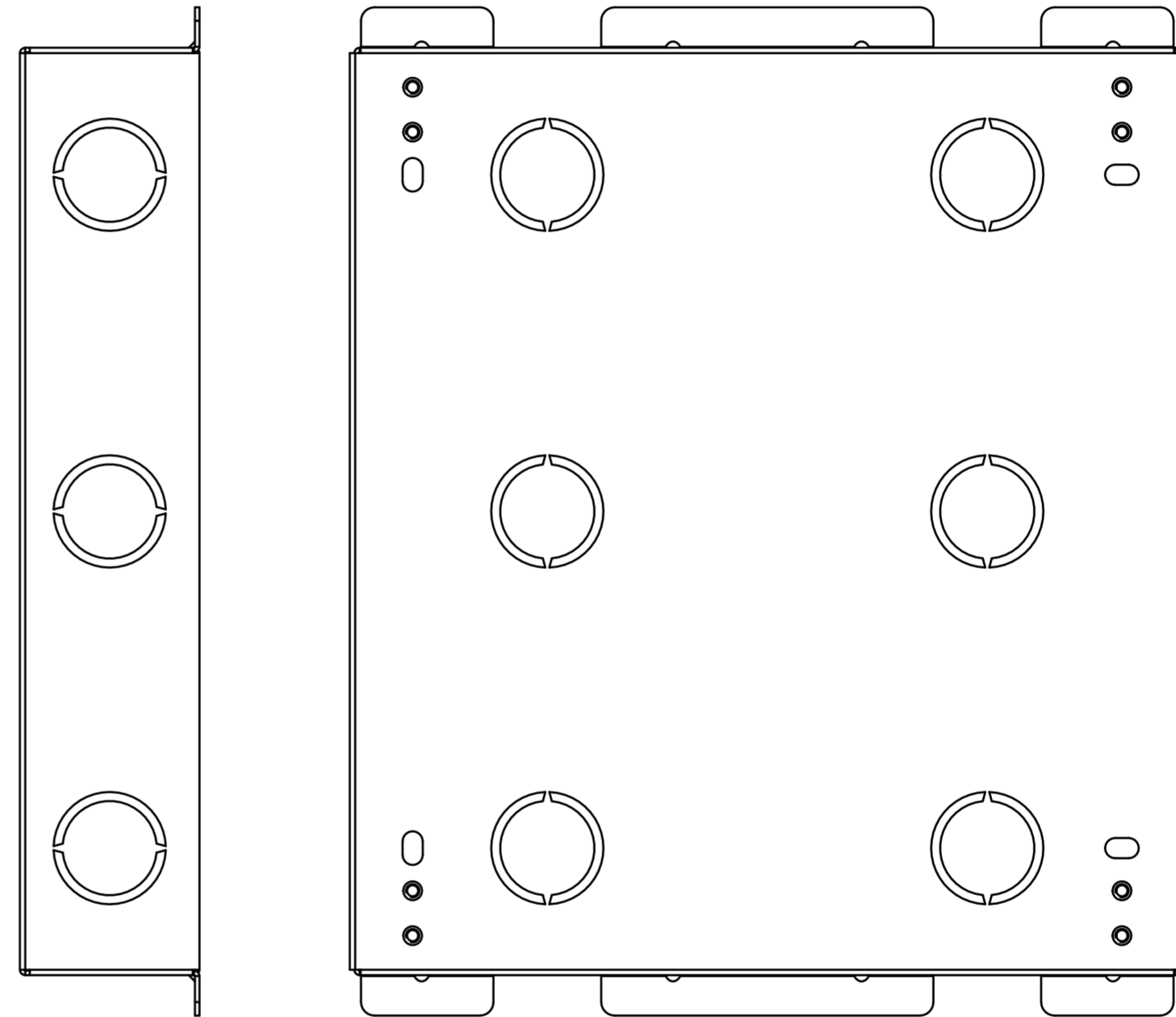

④ **BACK VIEW**

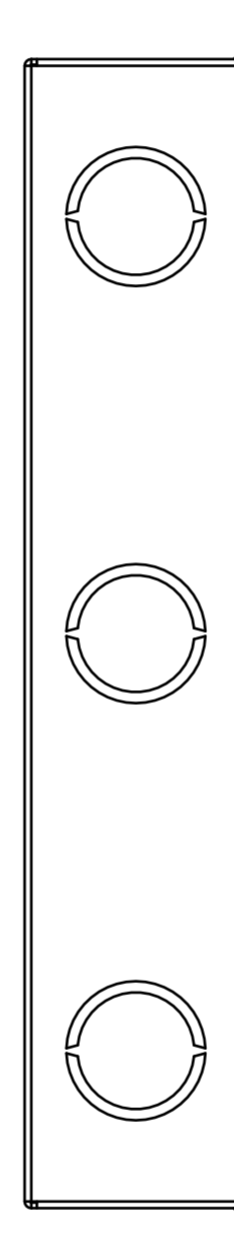

③ **LEFT VIEW**

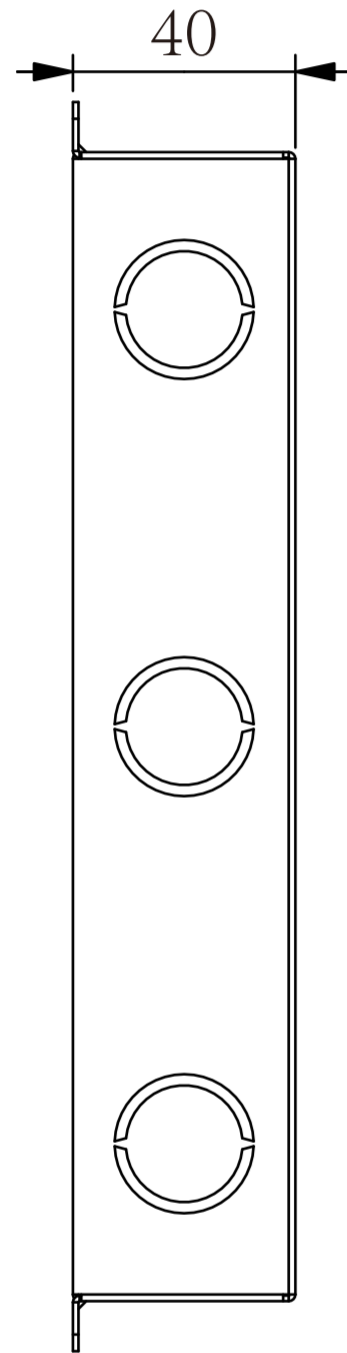

② **RIGHT VIEW**



⑤ **TOP VIEW**

**Applicable Model**

MD06-12

**Drawing Title**

Placement

**Drawing Unit**

mm

**Drawing Scale**

Not to scale

**DRAFT  
SUBJECT TO  
CHANGE**

**Last Revised**

Oct 30,2023

**Drawing Version**

V1.0

**Page**

5 of 8

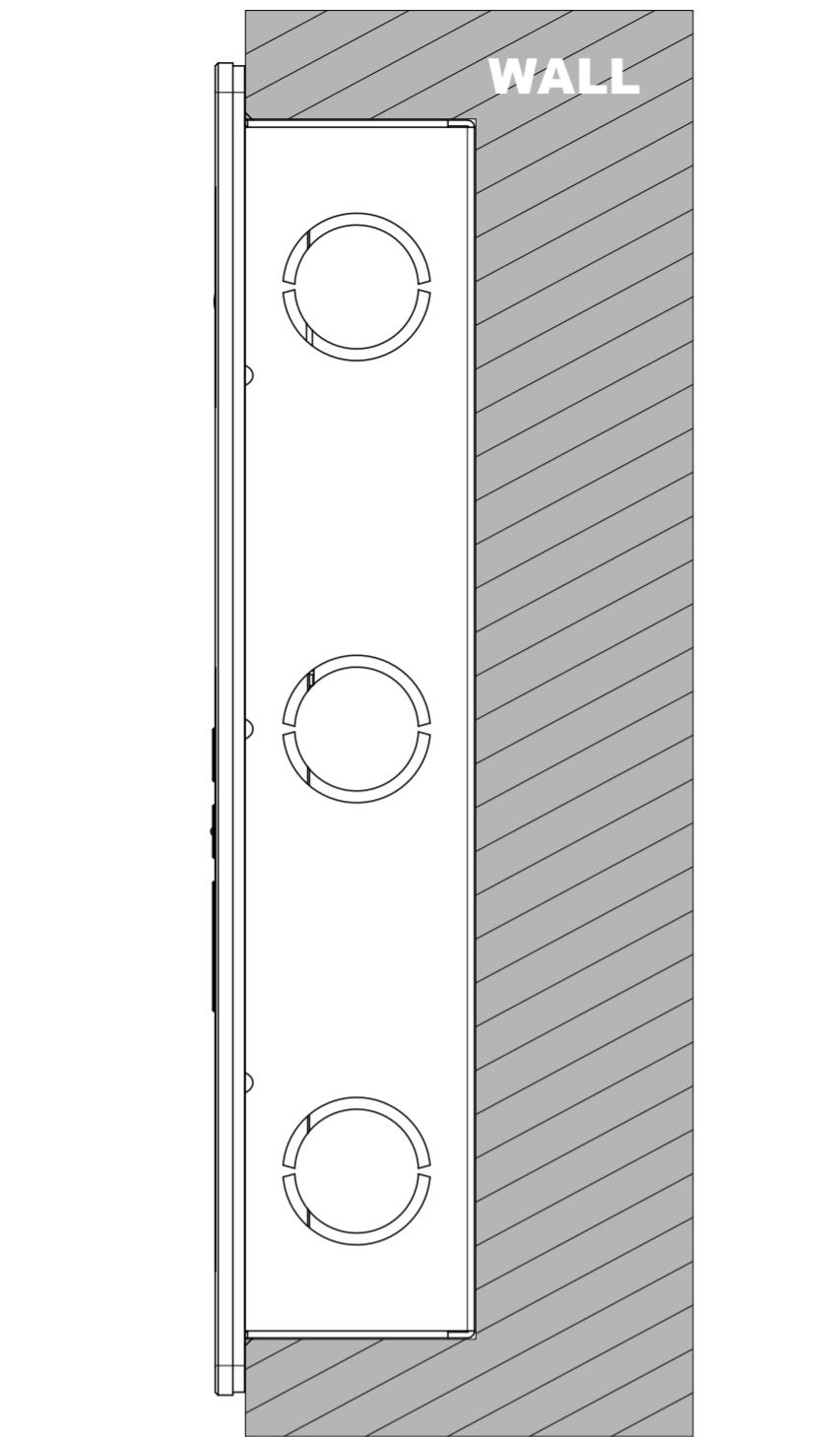
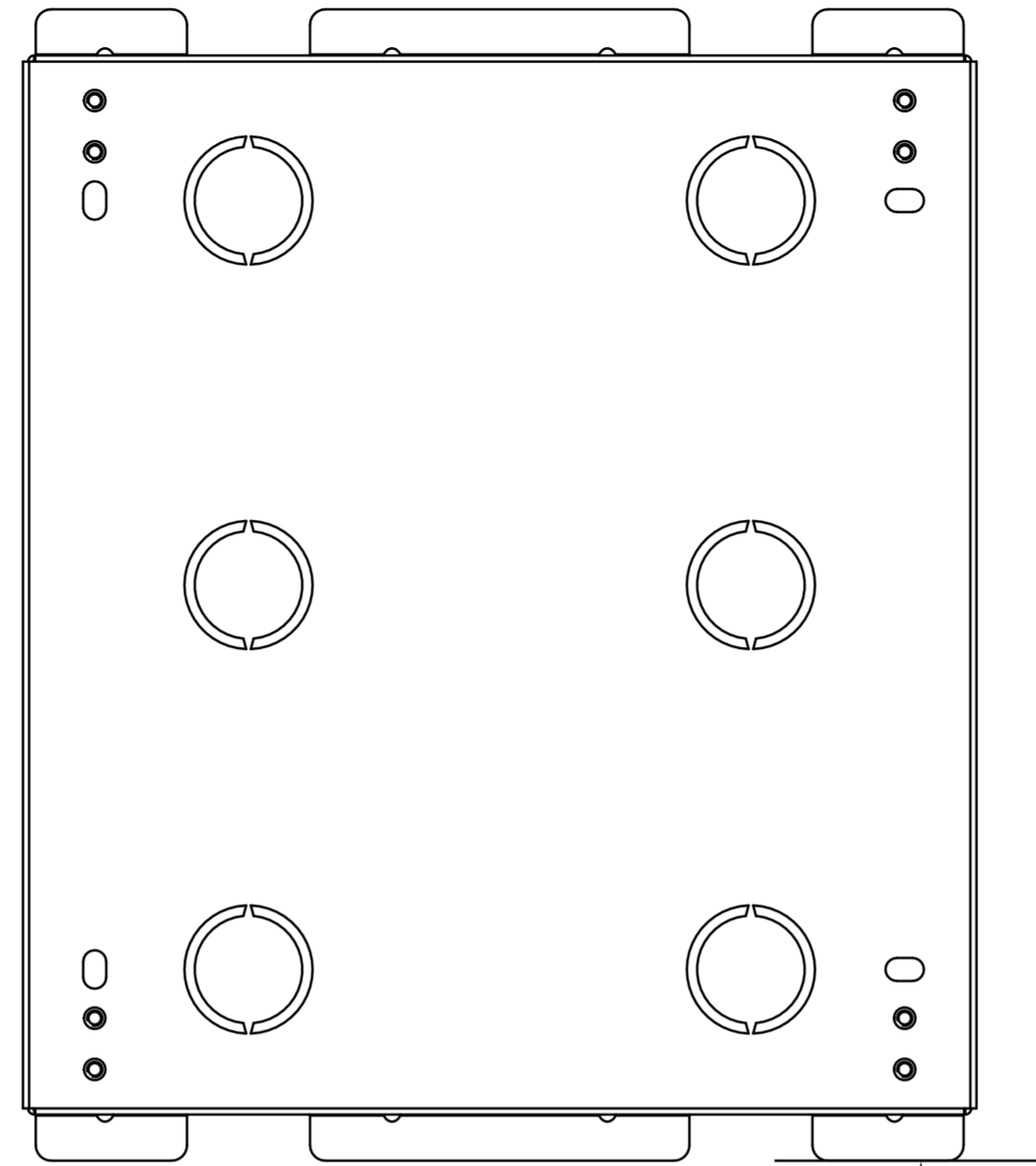
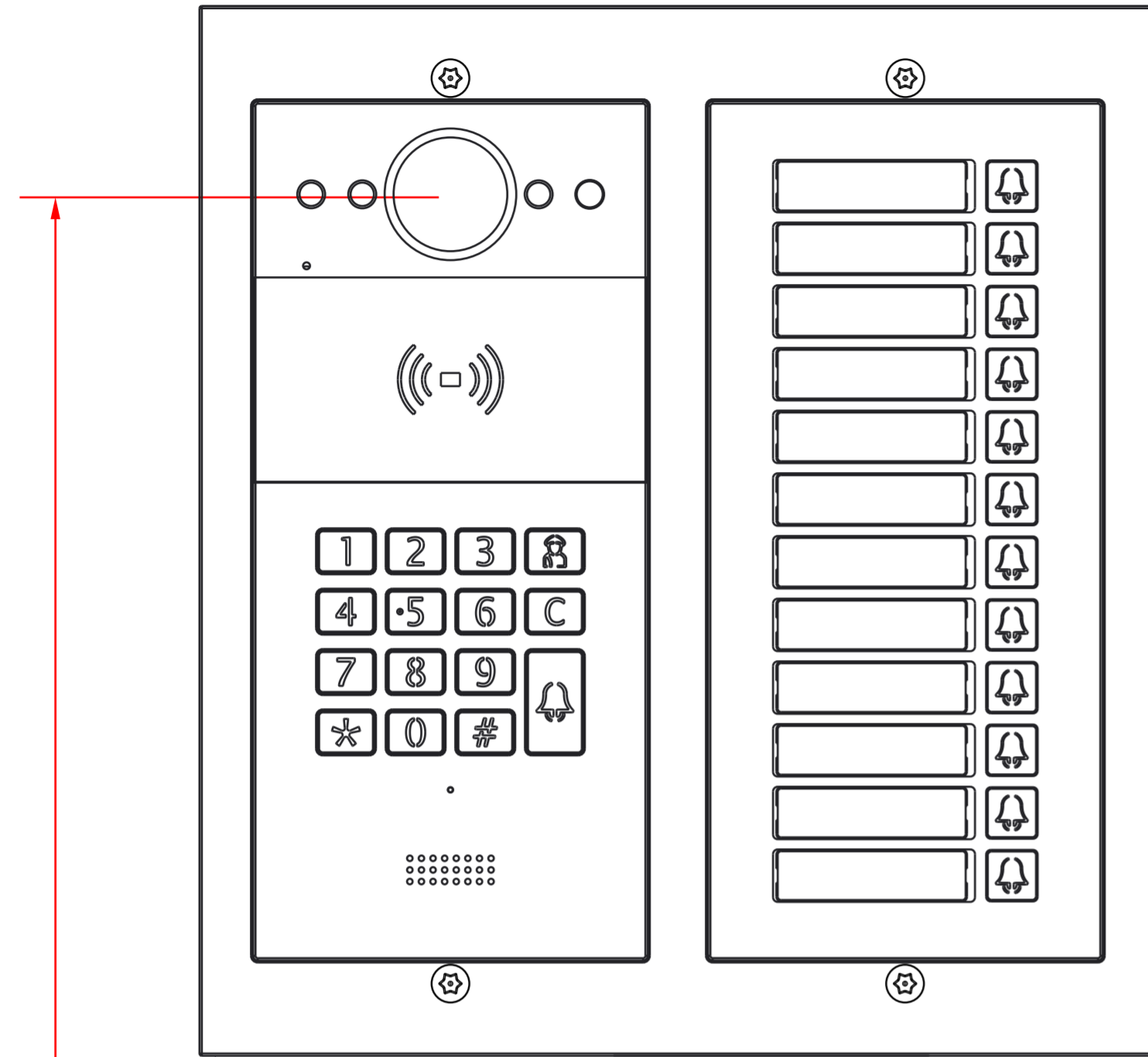

1400mm TO CENTER OF CAMERA

1214.5mm TO BOTTOM OF BRACKET

**ADA Compliance Requirement**

1215mm TO BOTTOM OF BRACKET

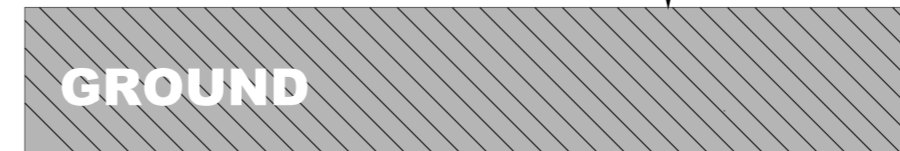

**Applicable Model**

MD06-12

**Drawing Title**

Triple Decorative Panels

**Drawing Unit**

mm

**Drawing Scale**

Not to scale

**DRAFT  
SUBJECT TO  
CHANGE**

**Last Revised**

Oct 30,2023

**Drawing Version**

V1.0

**Page**

6 of 8

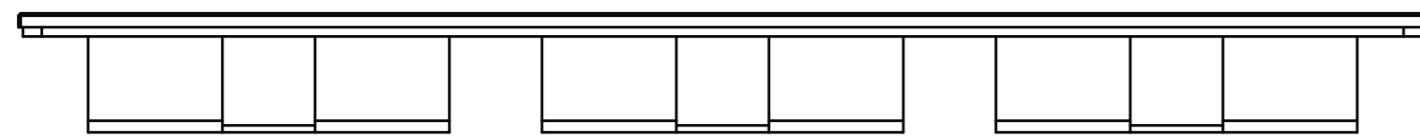

⑤ TOP VIEW

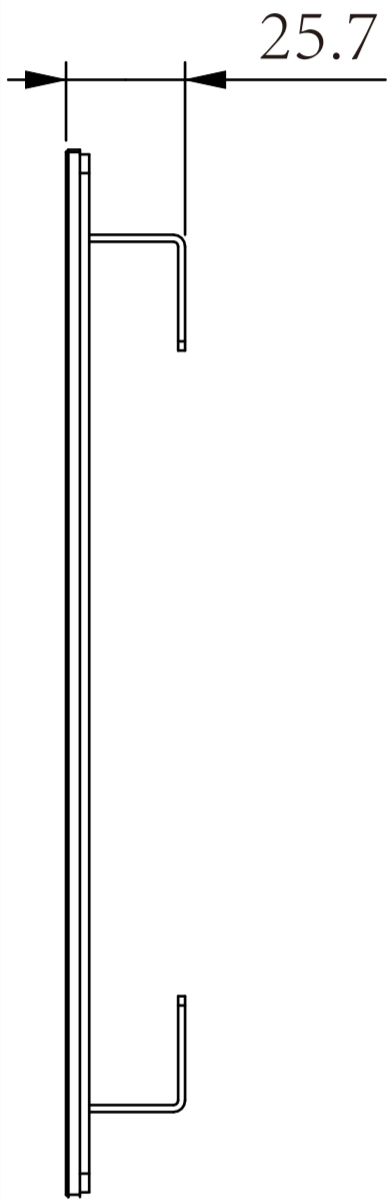

② RIGHT VIEW

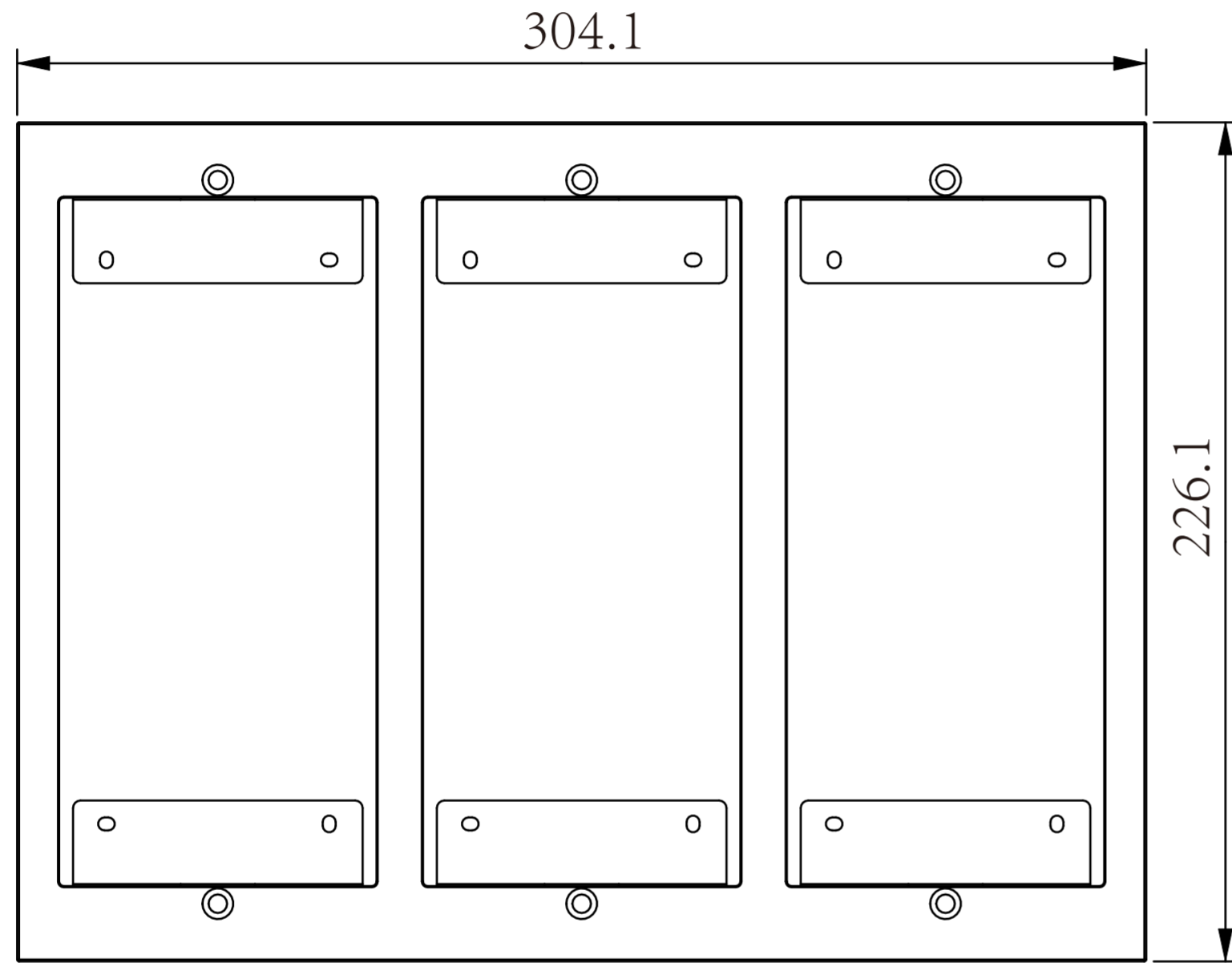

① FRONT VIEW

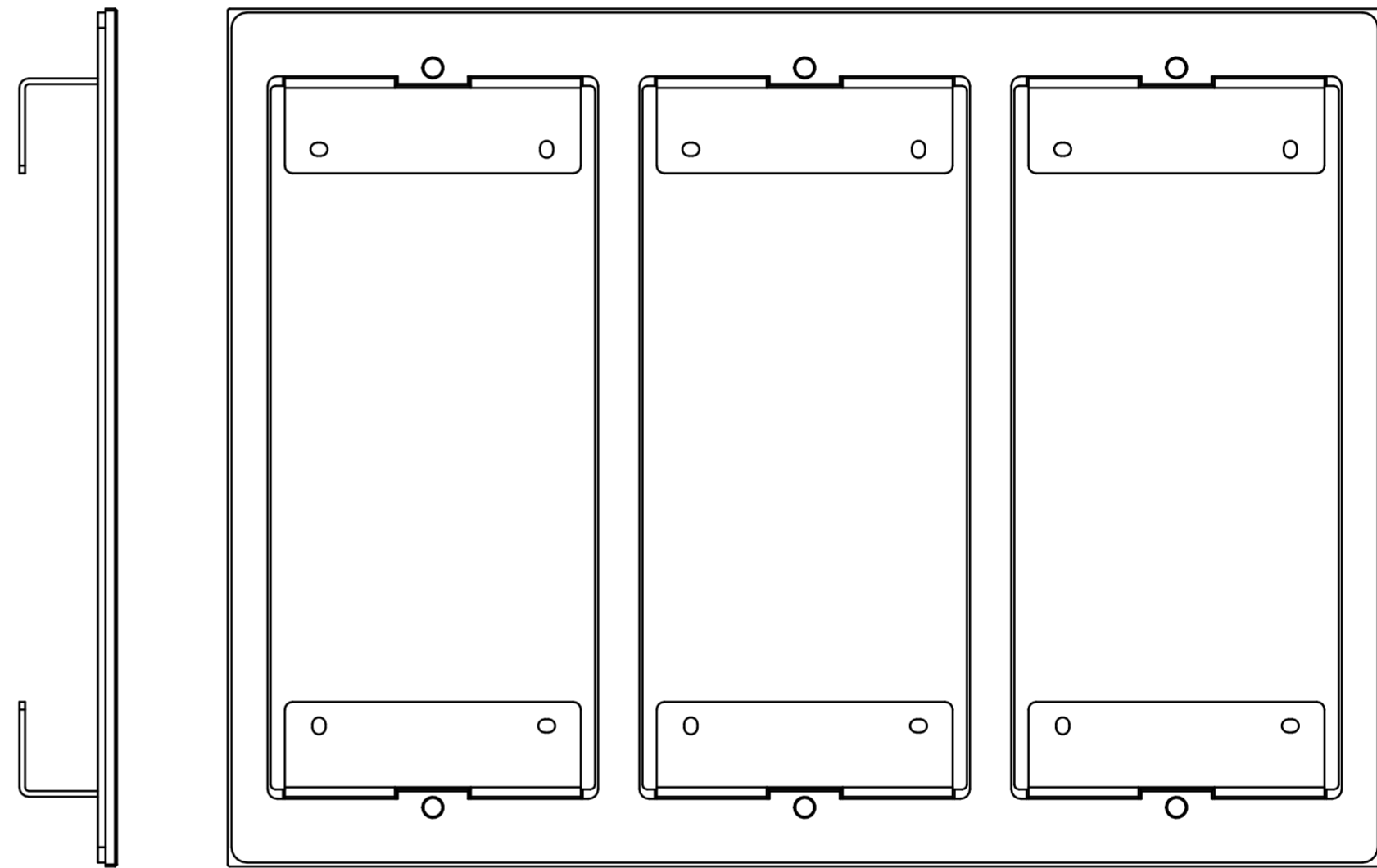

③ LEFT VIEW

④ BACK VIEW

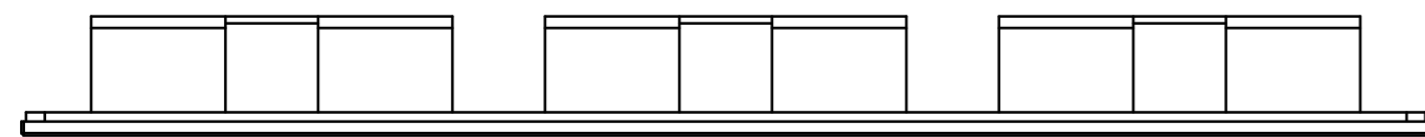

⑥ BOTTOM VIEW

**Applicable Model**

MD06-12

**Drawing Title**

Triple Flush  
Mounting Box

**Drawing Unit**

mm

**Drawing Scale**

Not to scale

**DRAFT  
SUBJECT TO  
CHANGE**

**Last Revised**

Oct 30,2023

**Drawing Version**

V1.0

**Page**

7 of 8

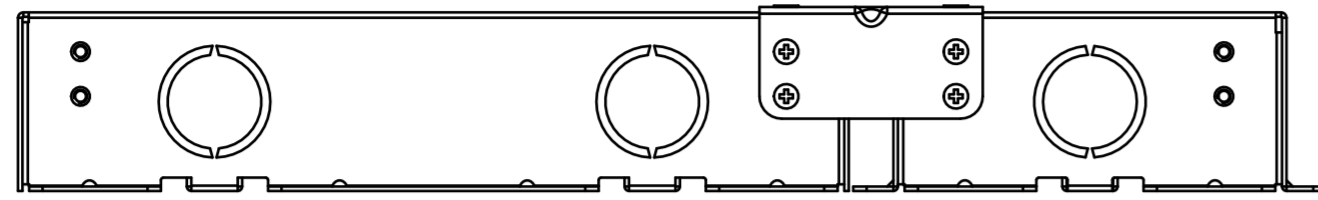

⑥ **BOTTOM VIEW**

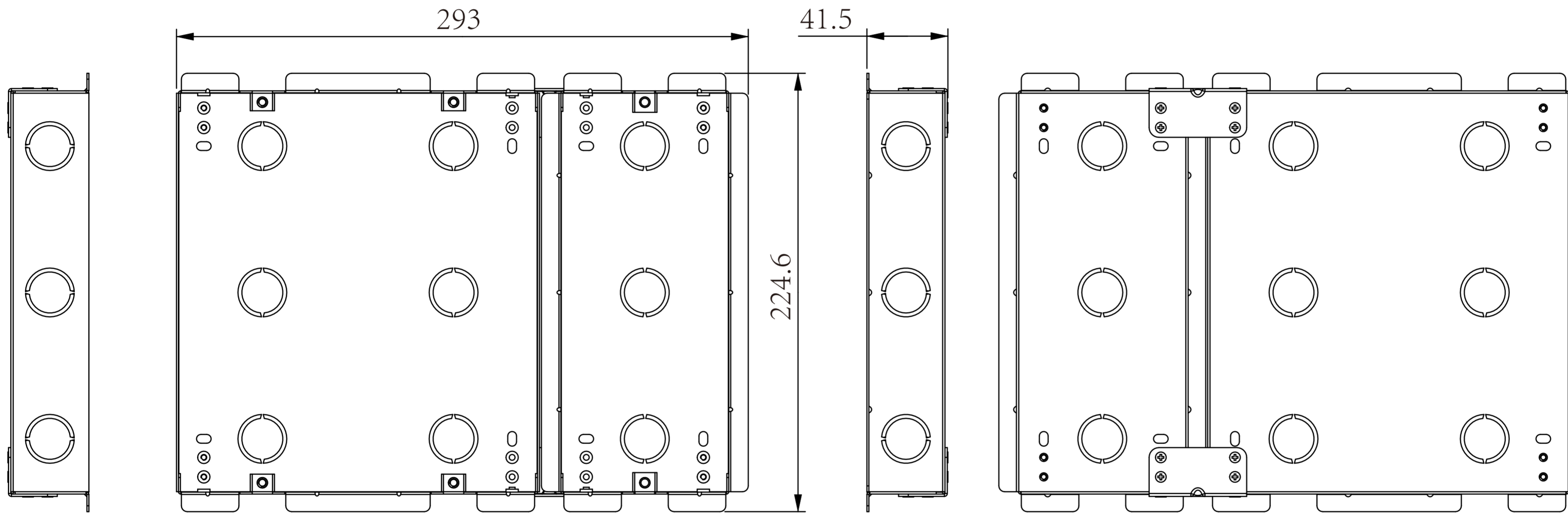

② **RIGHT VIEW**

① **FRONT VIEW**

③ **LEFT VIEW**

④ **BACK VIEW**

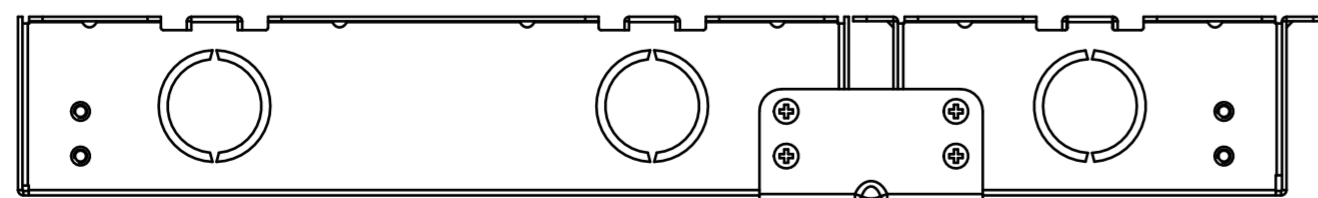

⑤ **TOP VIEW**

**Applicable Model**

MD06-12

**Drawing Title**

Placement

**Drawing Unit**

mm

**Drawing Scale**

Not to scale

**DRAFT  
SUBJECT TO  
CHANGE**

**Last Revised**

Oct 30,2023

**Drawing Version**

V1.0

**Page**

8 of 8

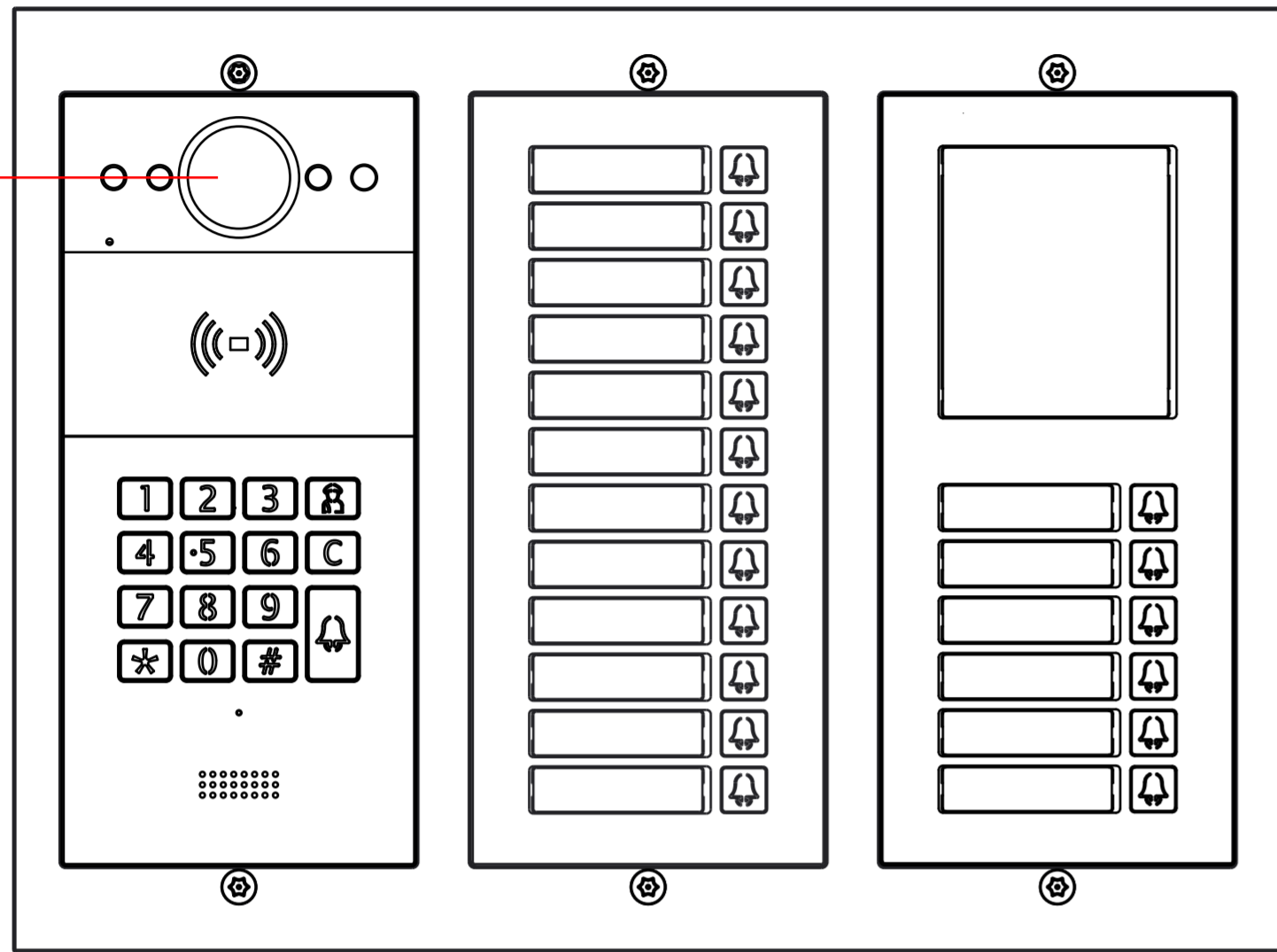

① INTERCOM PANEL FRONT VIEW

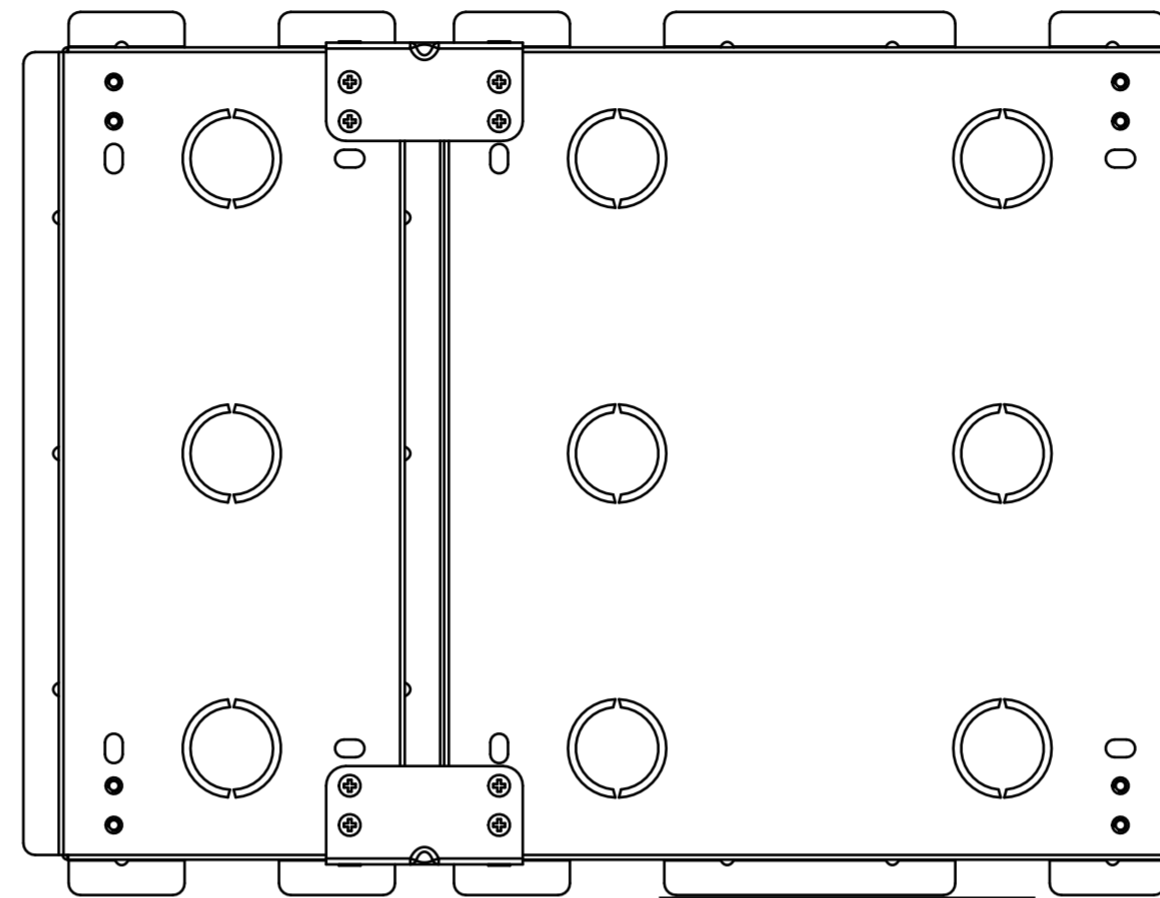

② FRONT VIEW: FLUSHING MOUNTING BOX PACEMENT

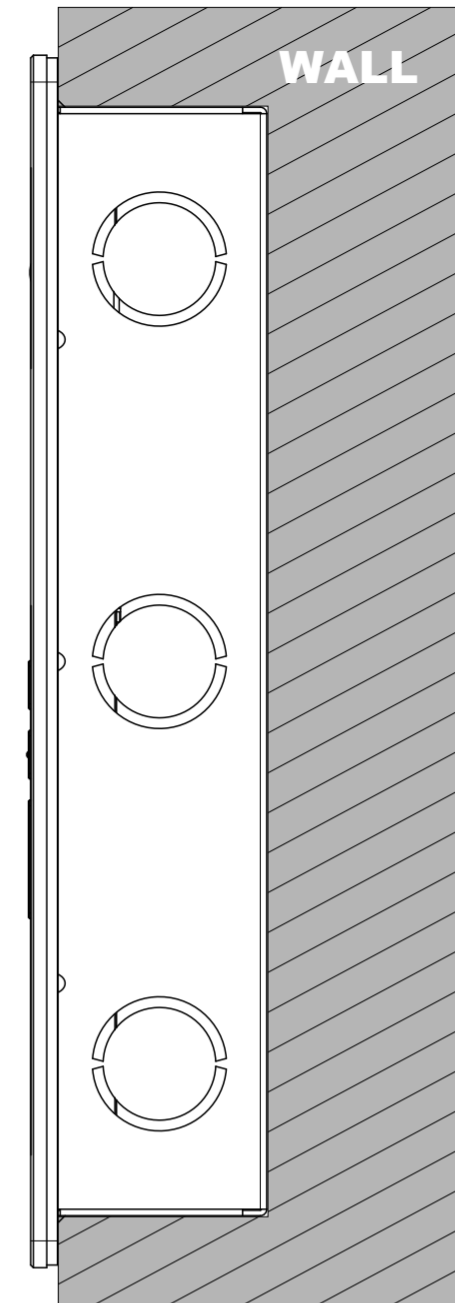

③ SIDE VIEW:INTERCOM PANEL IN WALL

1400mm TO CENTER OF CAMERA

1214.5mm TO BOTTOM OF BRACKET

**ADA Compliance Requirement**

GROUND

1215mm TO BOTTOM OF BRACKET

GROUND