

**Applicable Model**

HyPanel Pro  
PG71-KNX-EU

**Drawing Title**

Home Control Center  
Panel

**Drawing Unit**

mm

**Drawing Scale**

Not to scale

**DRAFT  
CHANGE TO  
SUBJECT**

**Last Revised**

Nov.22,2023

**Drawing Version**

V1.0

**Page**

1 of 2

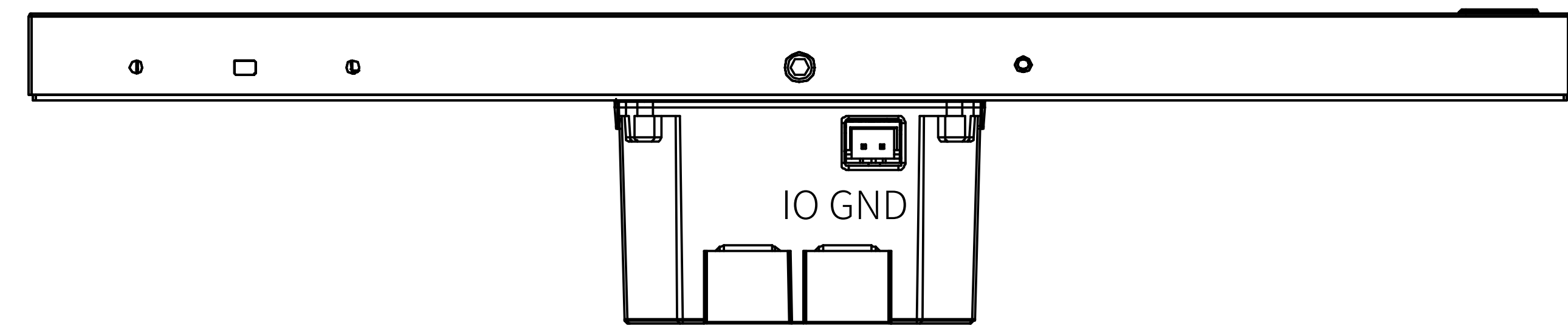

5 **BOTTOM VIEW**

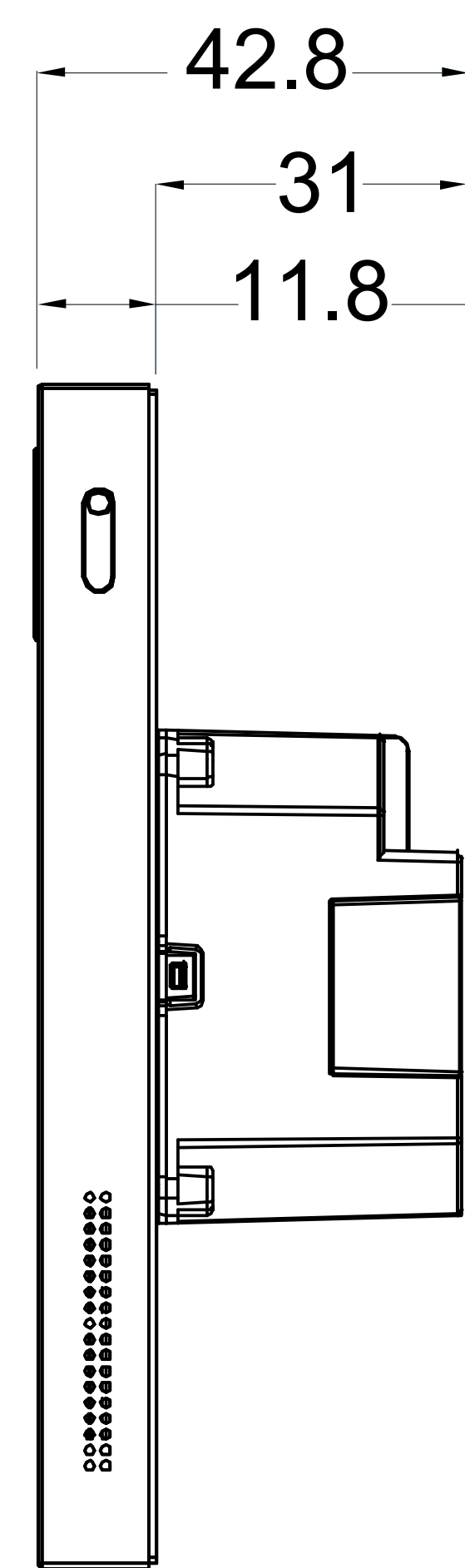

2 **RIGHT VIEW**

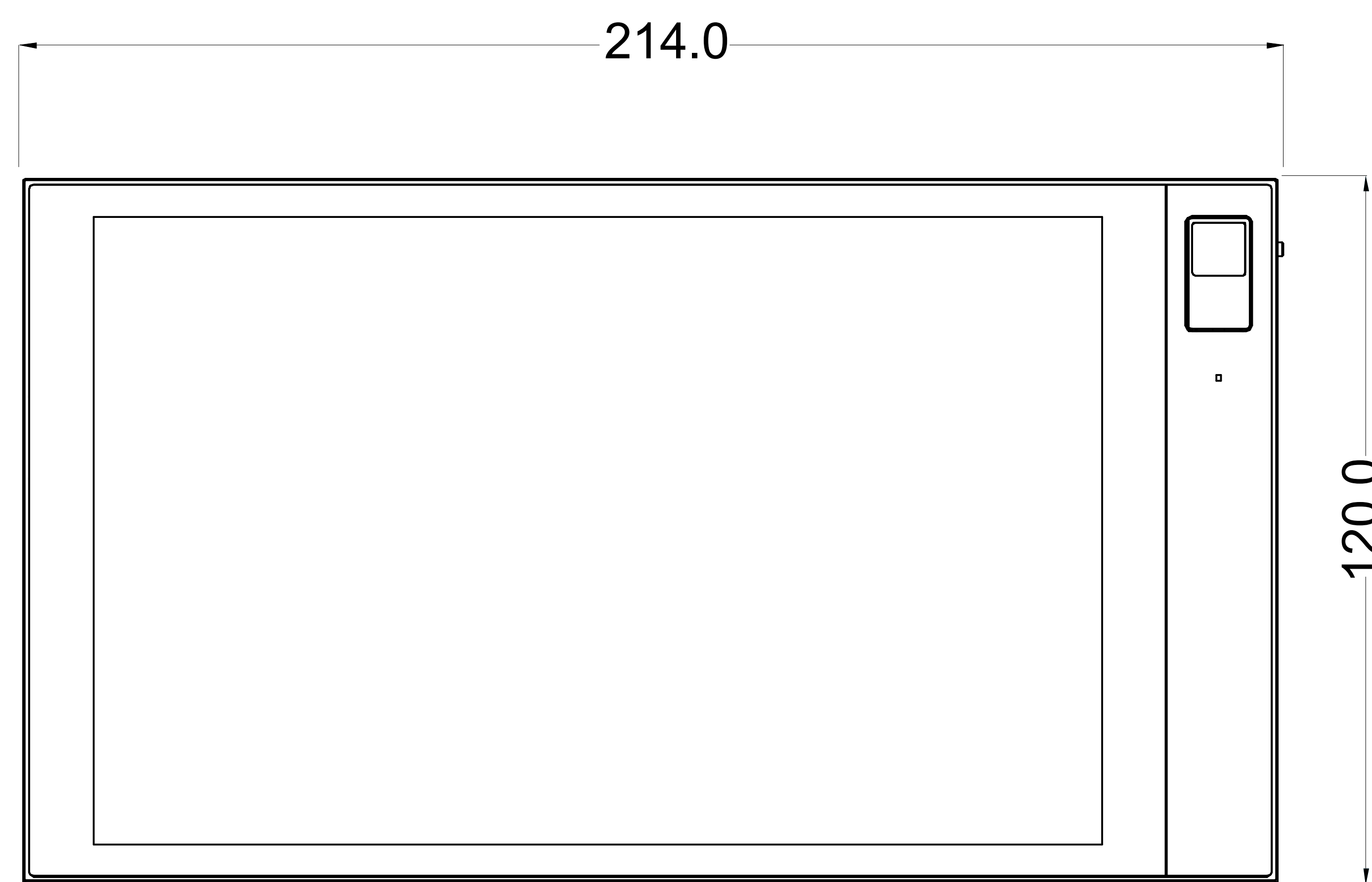

1 **FRONT VIEW**

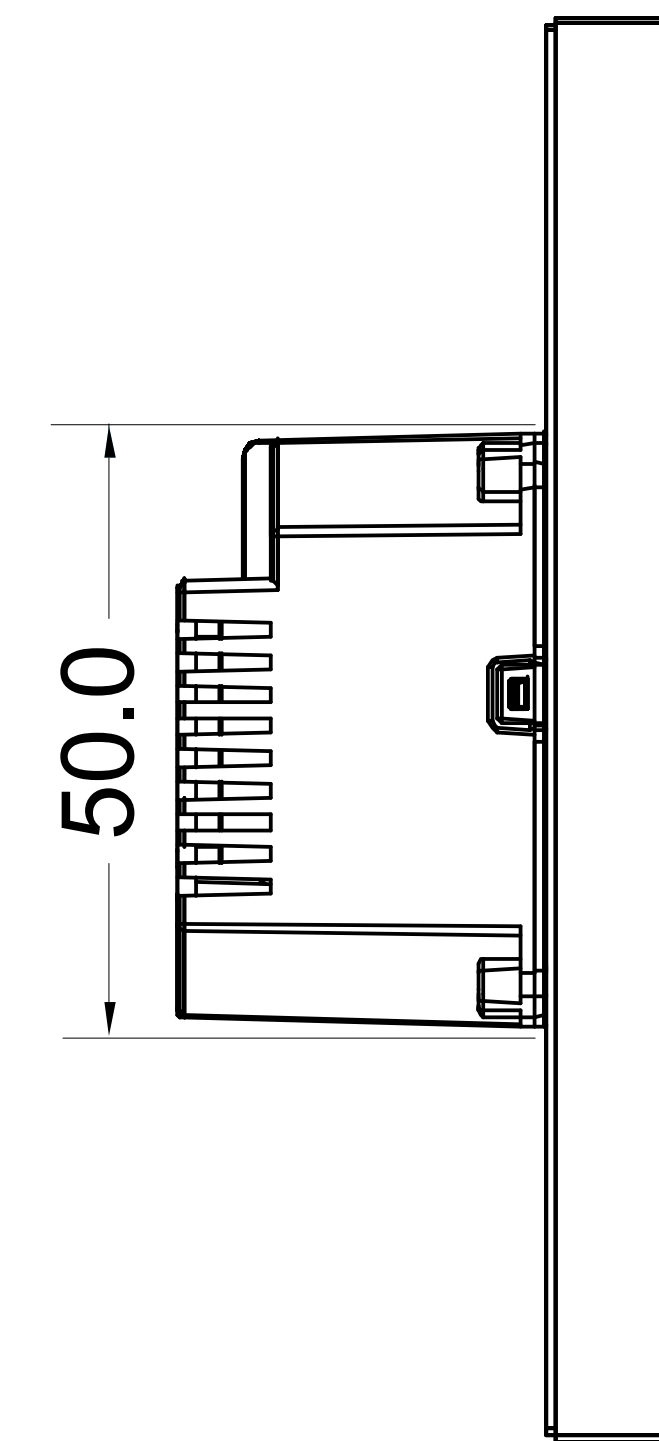

3 **LEFT VIEW**

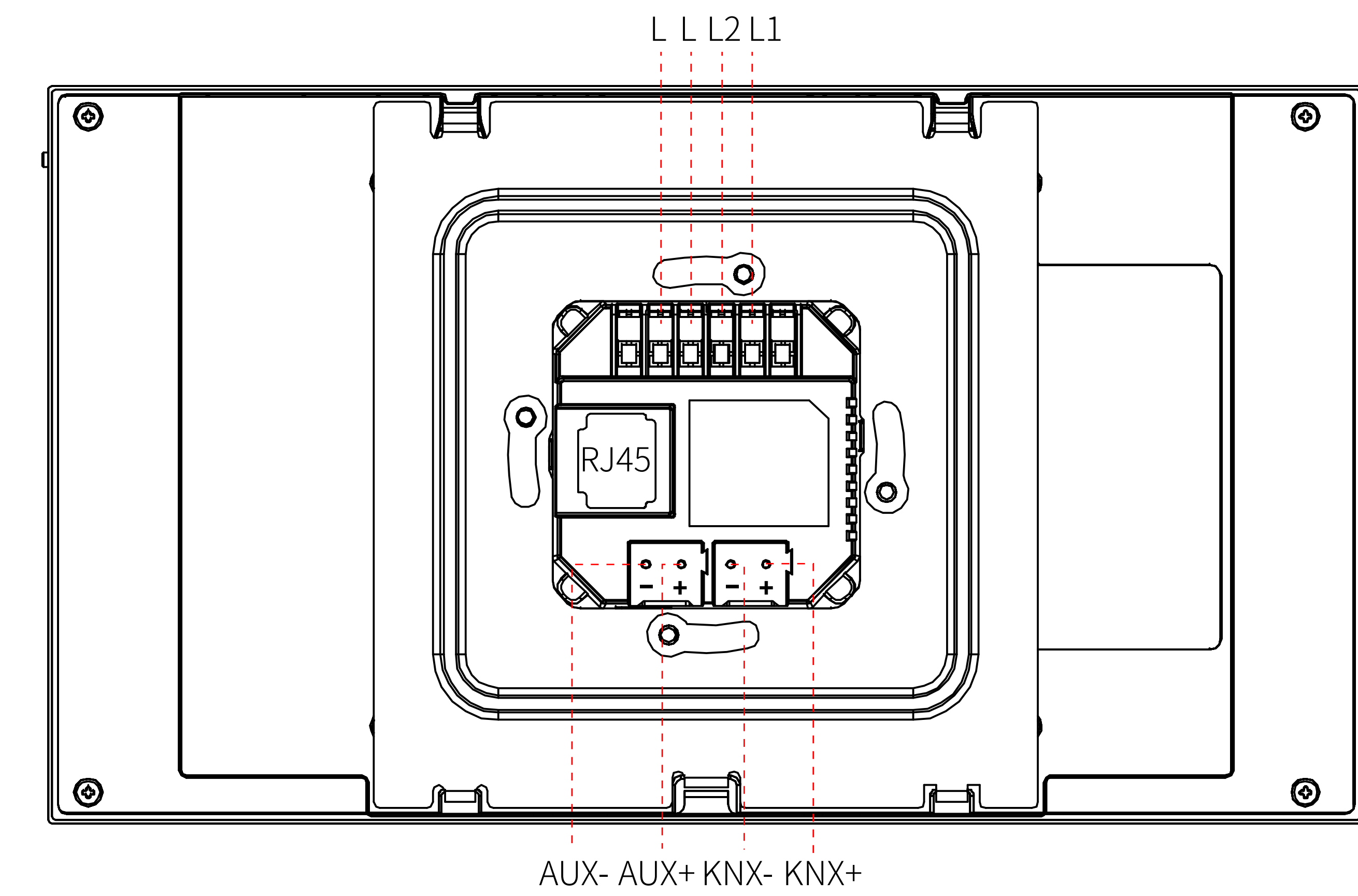

4 **BACK VIEW**

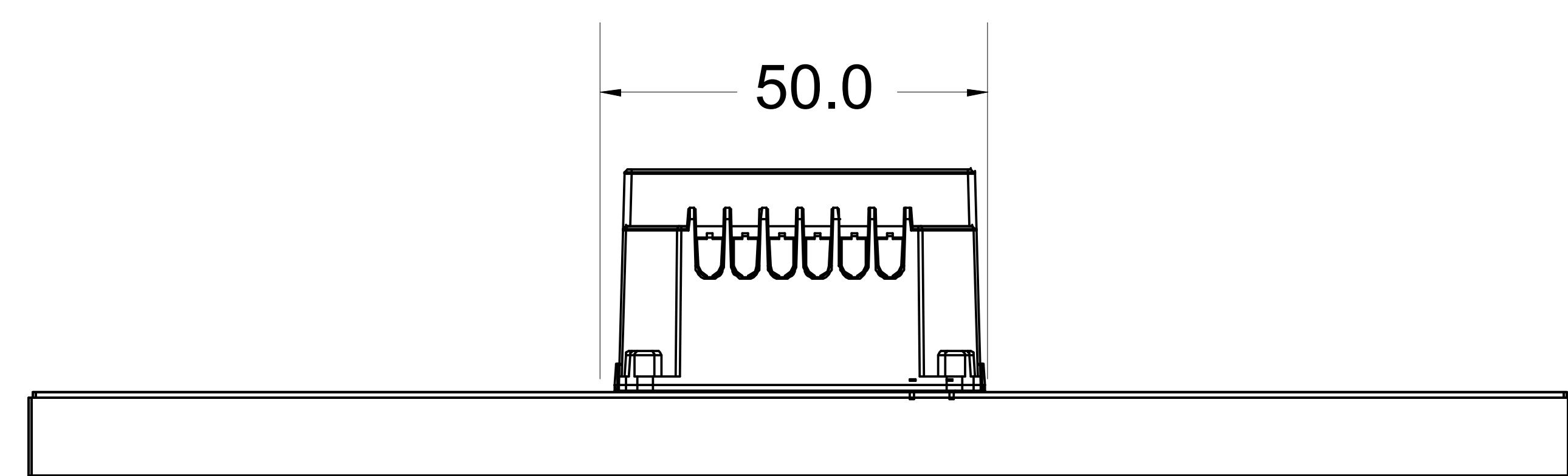

6 **TOP VIEW**

**Applicable Model**

HyPanel Pro  
PG71-KNX-EU

**Drawing Title**

Placement

**Drawing Unit**

mm

**Drawing Scale**

Not to scale

**DRAFT  
CHANGE TO  
SUBJECT**

**Last Revised**

Nov.22,2023

**Drawing Version**

V1.0

**Page**

2 of 2



① HYPANEL PRO FRONT VIEW

1100-1600mm TO BOTTOM OF PANEL

ADA Compliance Requirement

GROUND

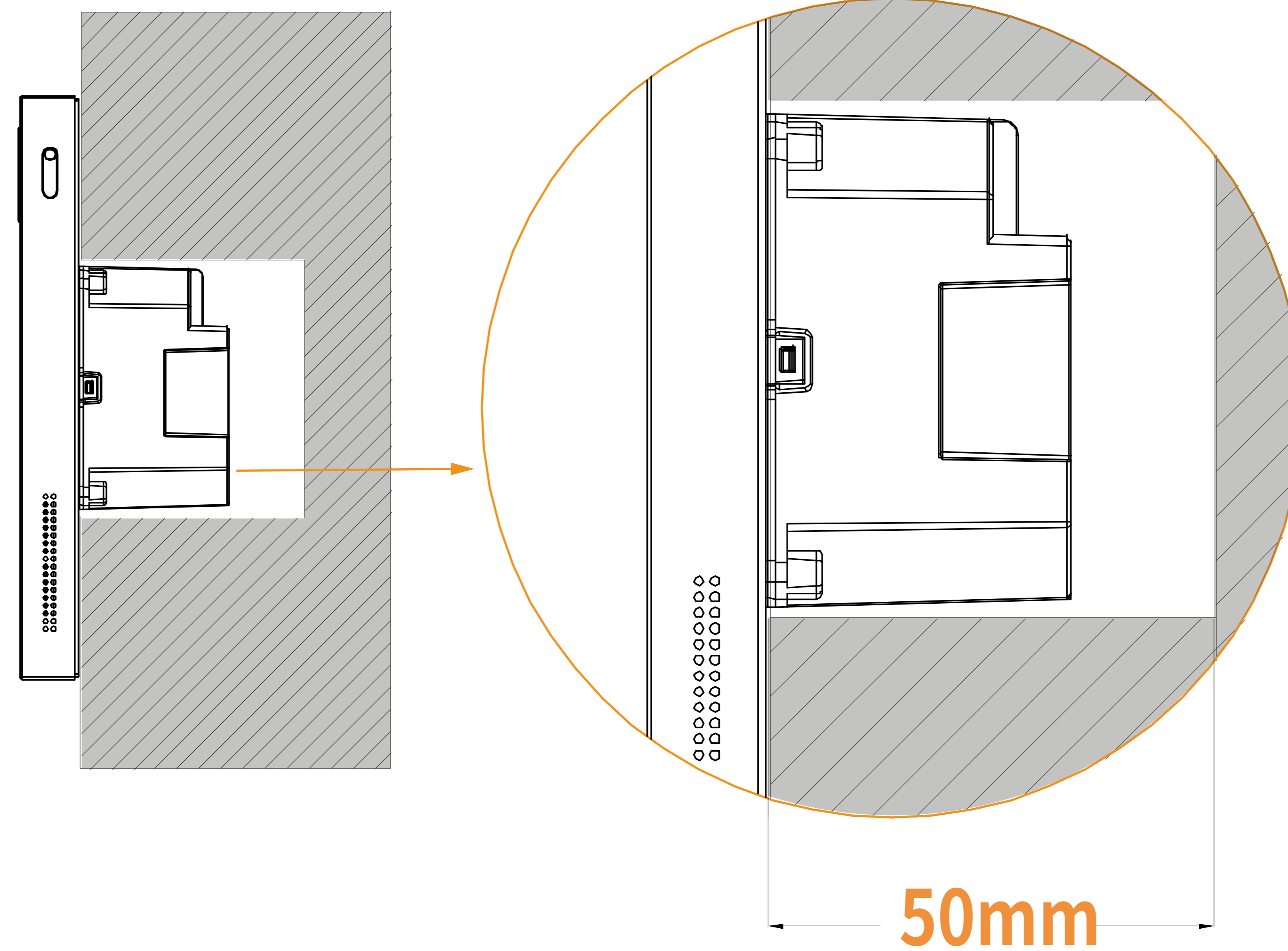

② SIDE VIEW:HYPANEL PRO IN WALL

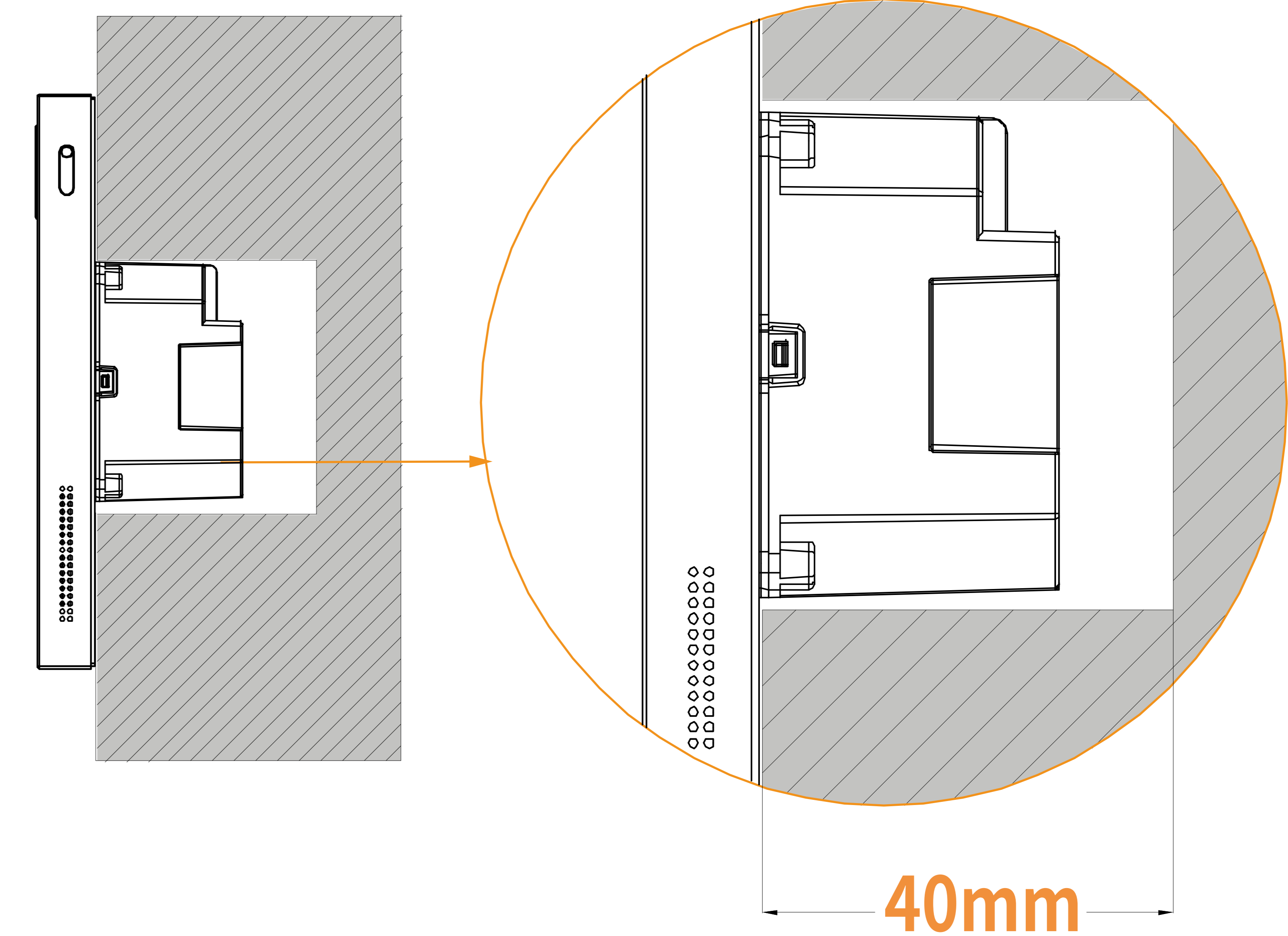

A 50 mm (2 inches) deep electrical box is highly recommended for ease of installation. In some scenarios, especially when the wires can be pushed back into the wall far enough, it may be possible to use a 40mm(1.6 inches) deep box.