

Applicable Model

HyPanel Plus
PS52-R2-EU
PS52V2-R2-EU

Drawing Title

Home Control Center
Panel

Drawing Unit

mm

Drawing Scale

Not to scale

**DRAFT
CHANGE TO
SUBJECT**

Last Revised

Jan.25.2024

Drawing Version

V1.0

Page

1 of 2

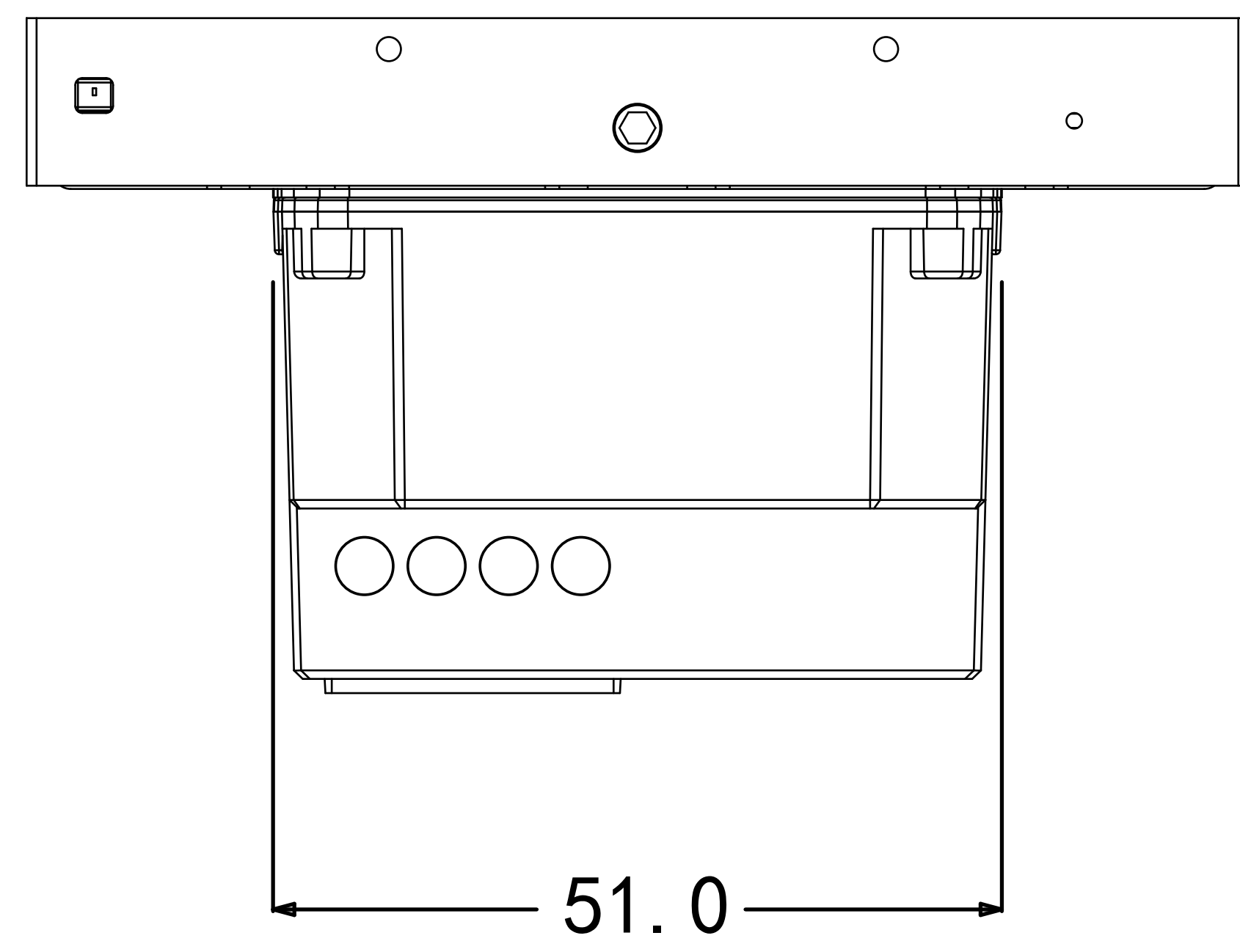

5 **BOTTOM VIEW**

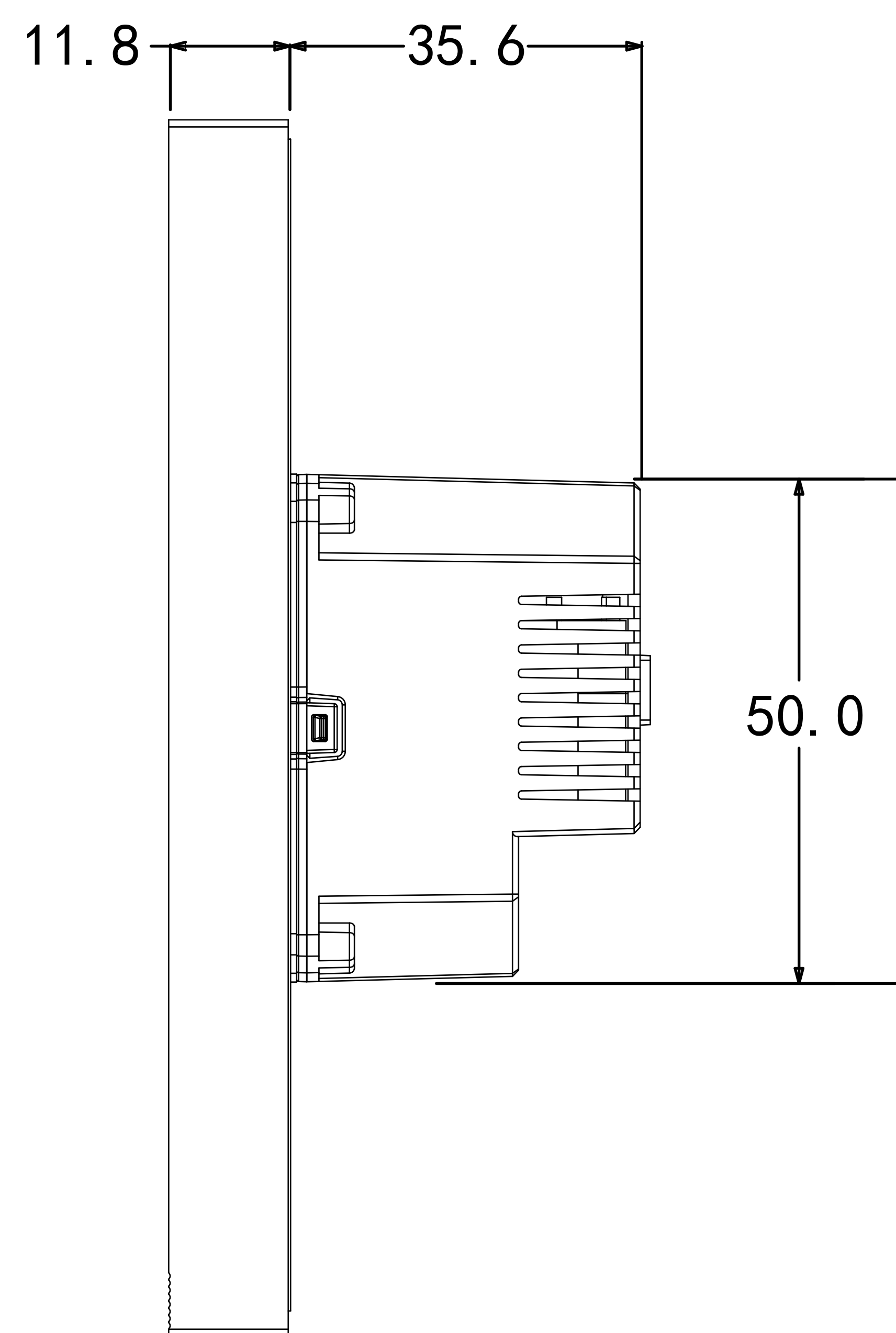

2 **RIGHT VIEW**

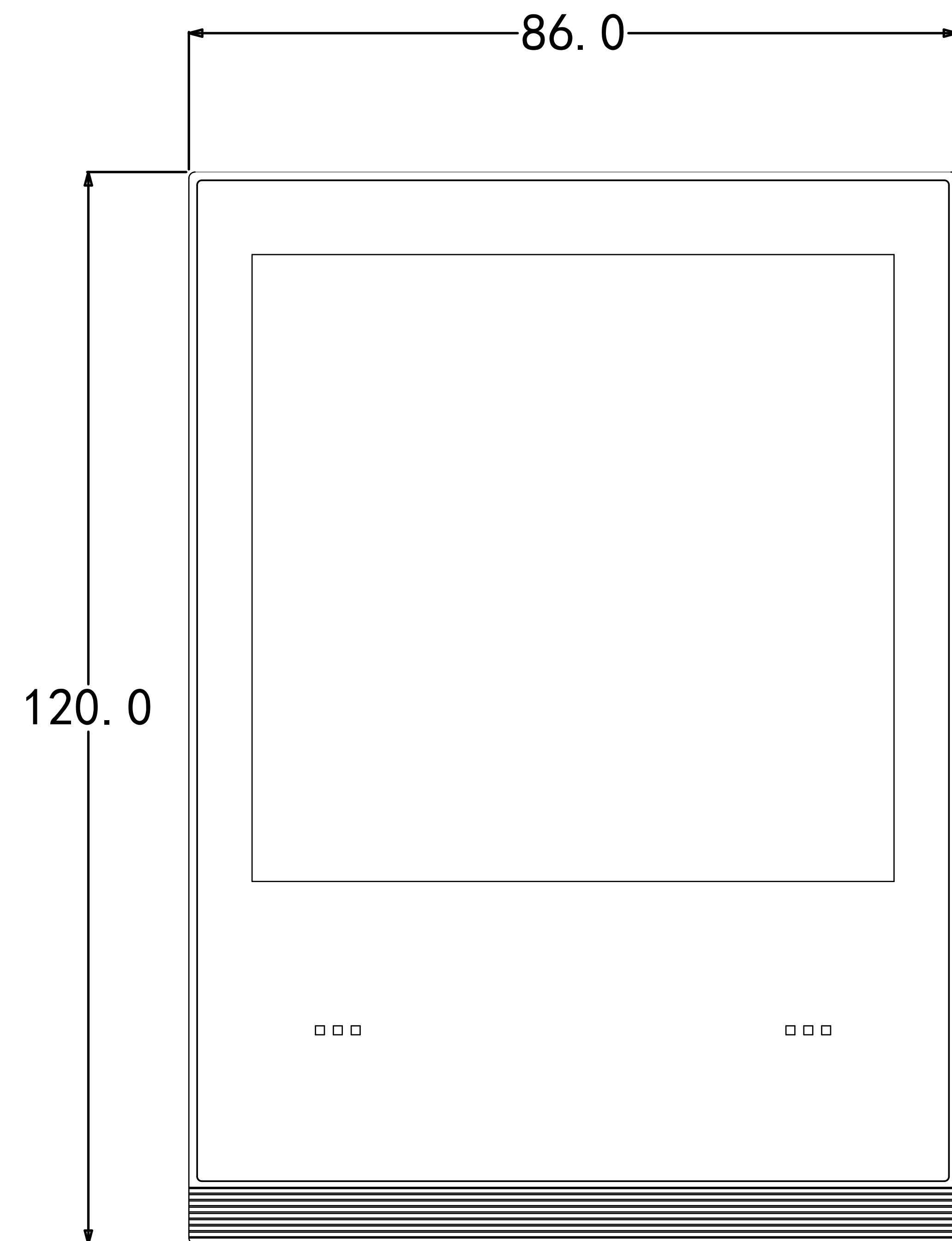

1 **FRONT VIEW**

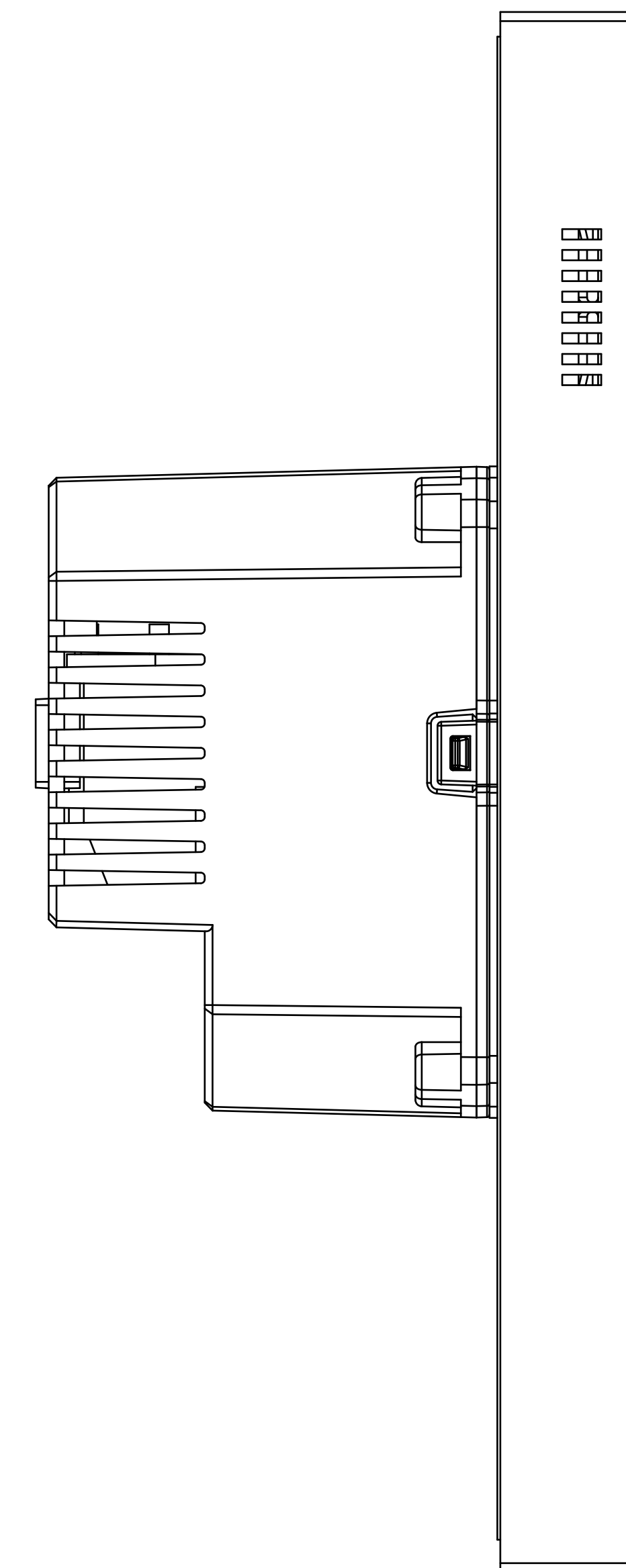

3 **LEFT VIEW**

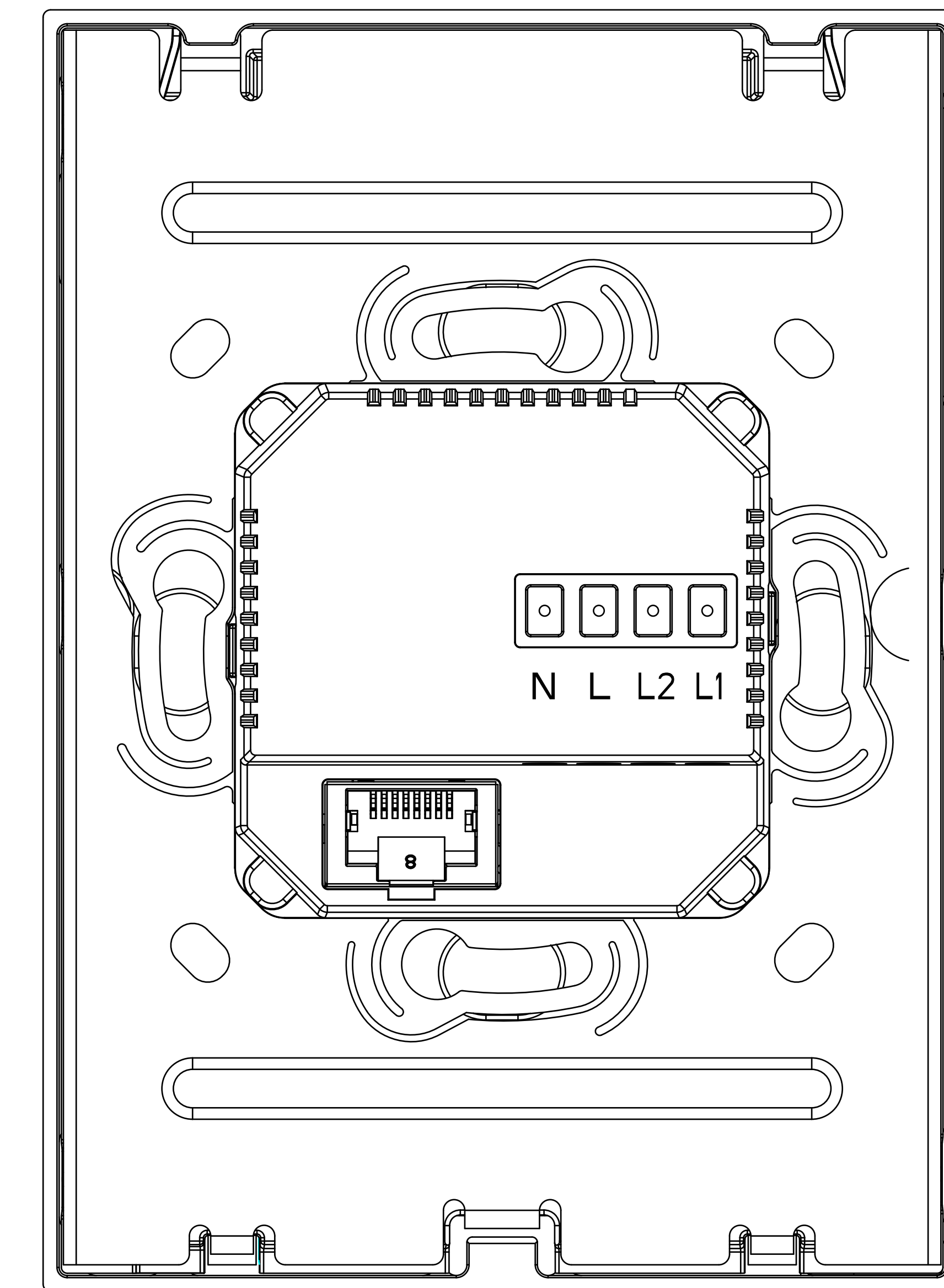

4 **BACK VIEW**

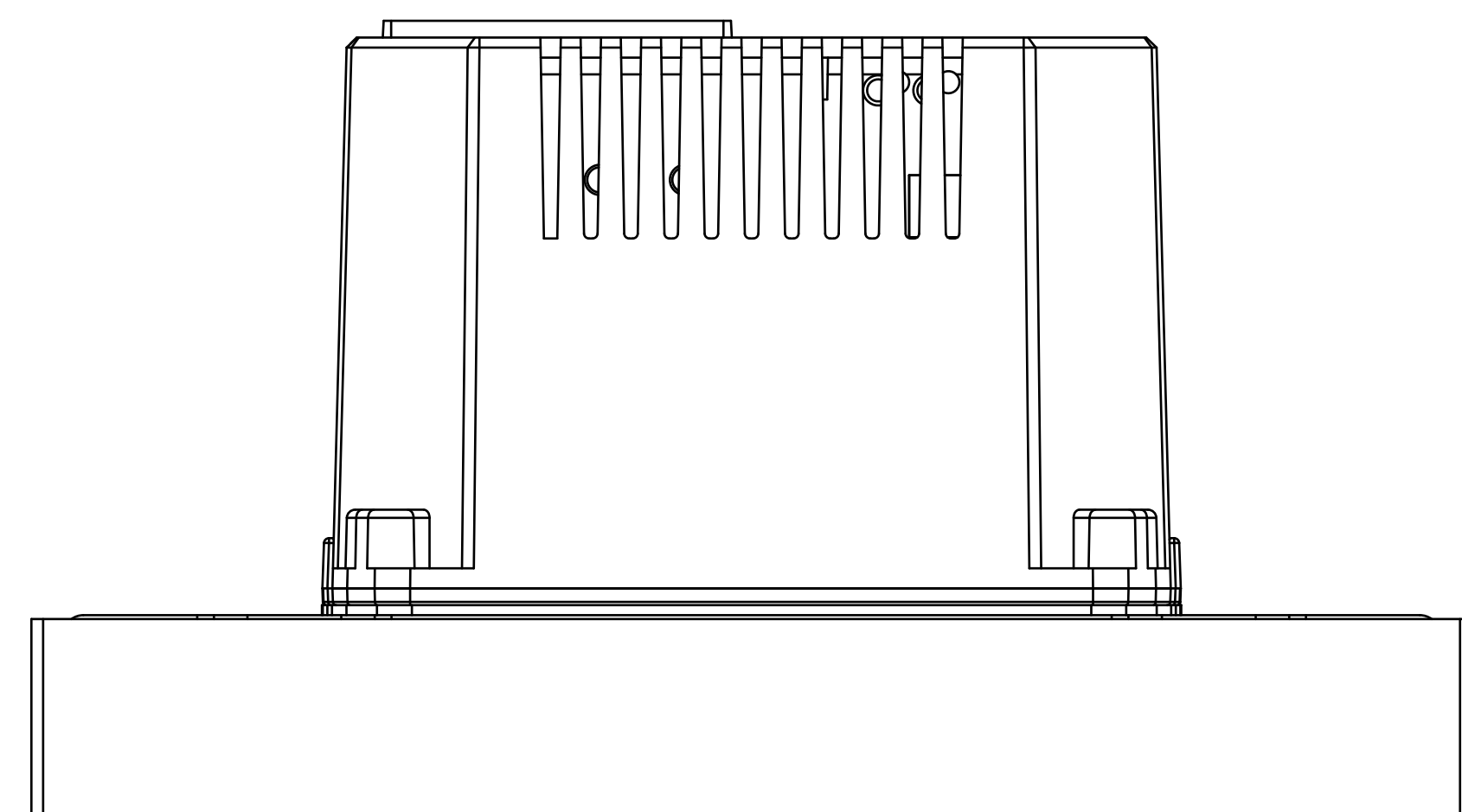

6 **TOP VIEW**

Applicable Model

HyPanel Plus
PS52-R2-EU
PS52V2-R2-EU

Drawing Title

Placement

Drawing Unit

mm

Drawing Scale

Not to scale

**DRAFT
CHANGE TO
SUBJECT**

Last Revised

Jan.25.2024

Drawing Version

V1.0

Page

2 of 2

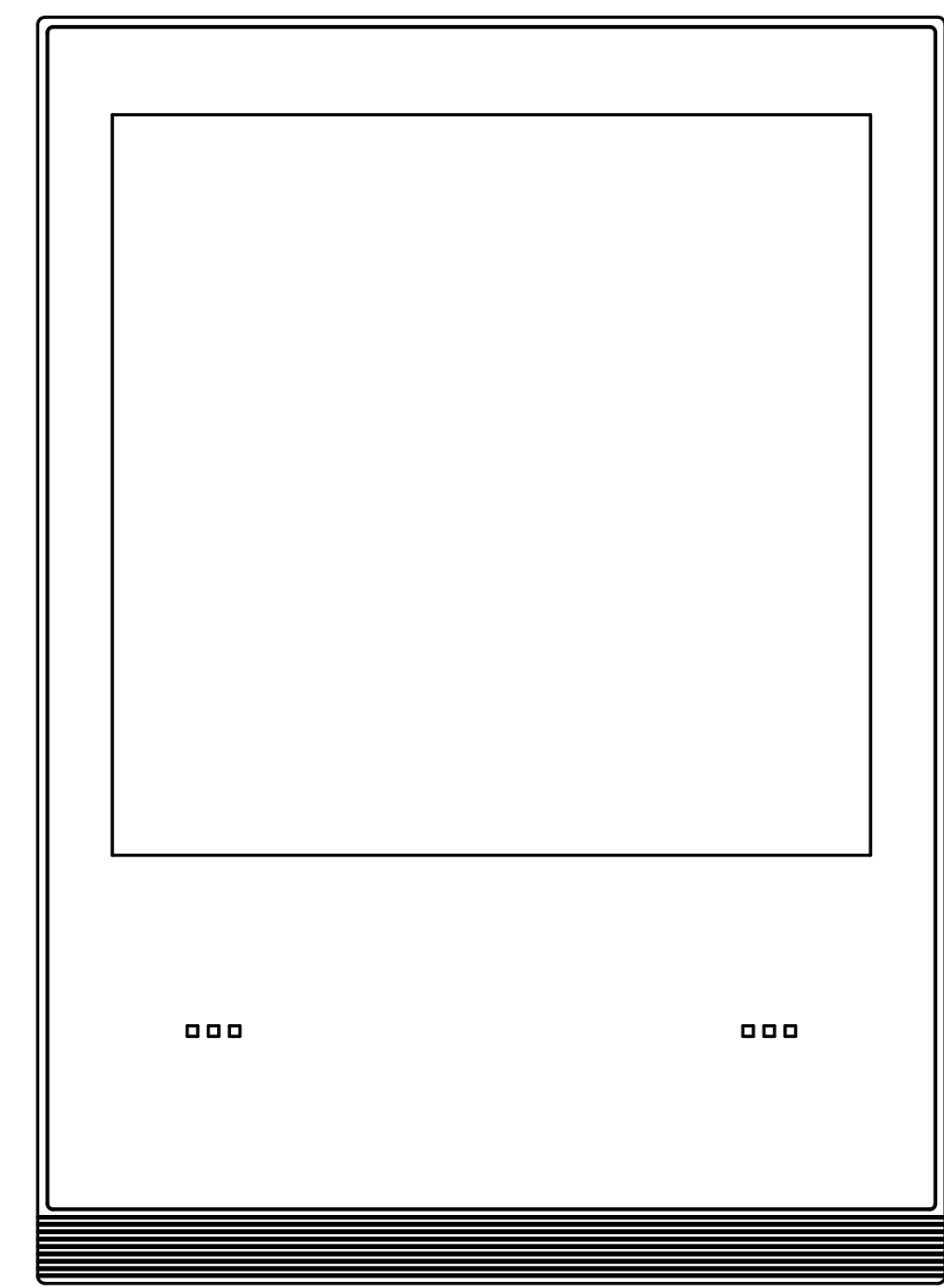

① HYPANEL FRONT VIEW

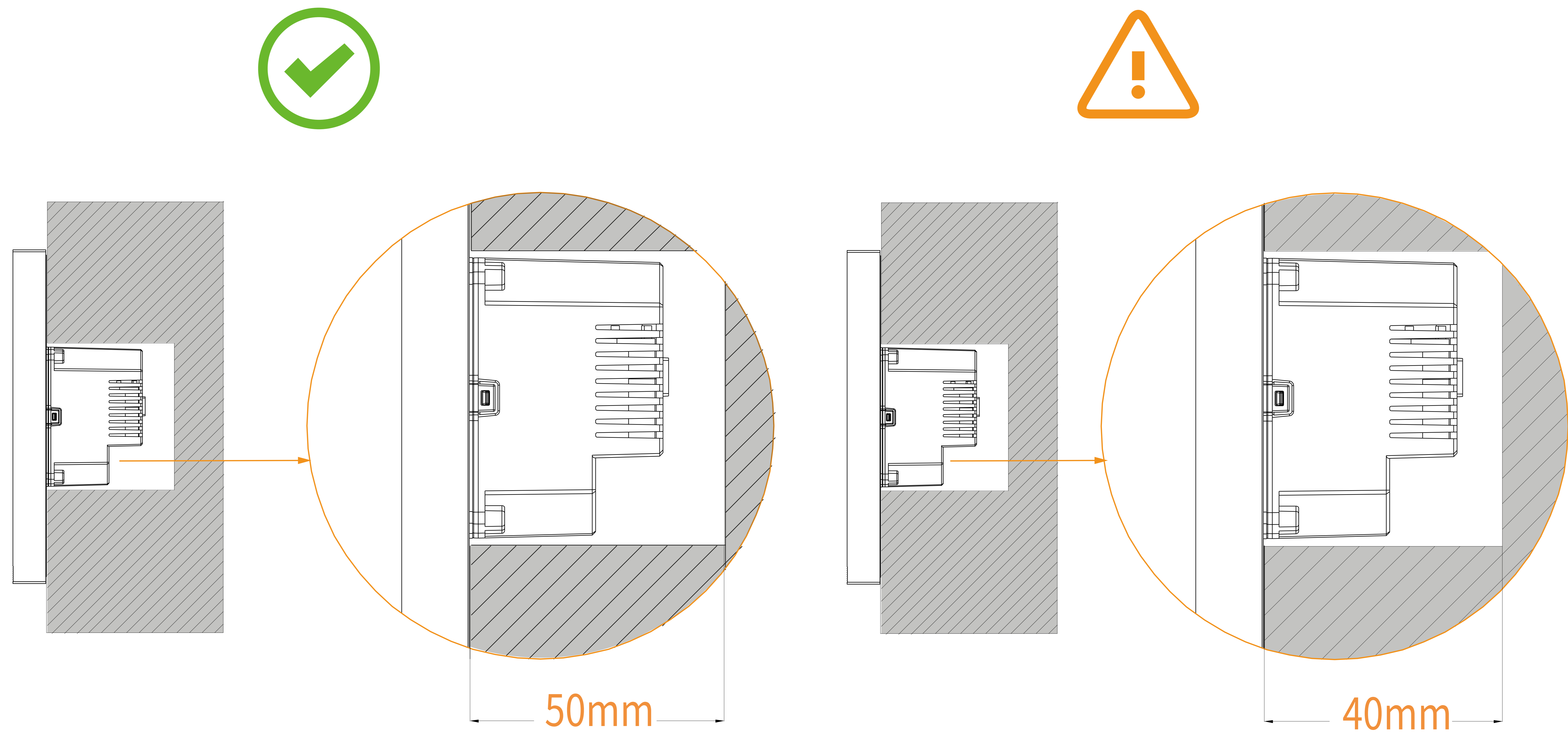

② SIDE VIEW:HYPANEL IN WALL

1100-1600mm TO BOTTOM OF PANEL

ADA Compliance Requirement

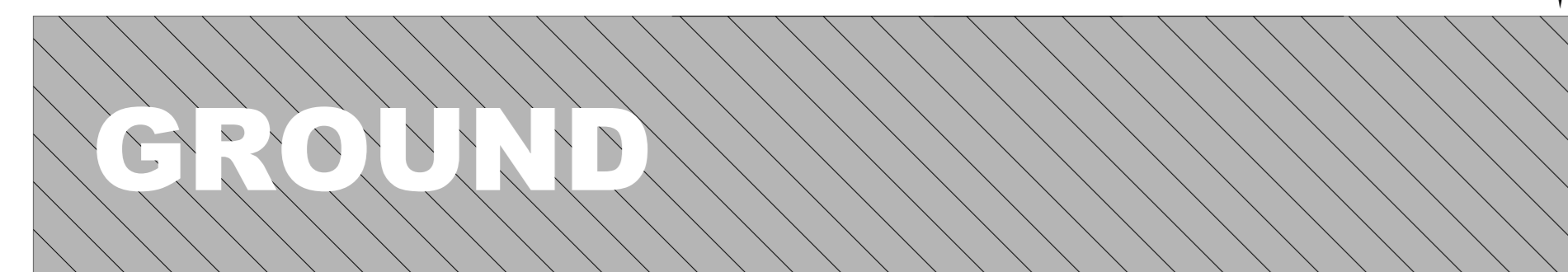

A 50mm(2inches) deep electrical box is highly recommended for ease of installation. In some scenarios, especially when the wires can be pushed back into the wall far enough, it may be possible to use a 40mm(1.6 inches) deep box.